



Quick Connects



QC & QF Series

- Pressure: Up to 6000 psig (413 bar)
- Temperature: -40 to 450° F (-40 to 232° C)

- Single-End Shut Off, Double End Shut Off & Full Flow





At SSP, we are proud to be an American manufacturing success story.

100% of our products are made in America. All of our manufacturing is performed in our 165,000 sq. ft. facility located near Cleveland, Ohio. Our facility is the largest vertically integrated, single-site operation in the industry. In addition to manufacturing and assembly, we have closed die forging, tool & die design, product development and testing operations under the same roof with the customer service and executive teams.

Made in America is good business. Not only do we make everything in America, we use American suppliers too. Buying American allows us to have better quality control and a more reliable supply chain. We can work more closely within our walls and with our suppliers to improve quality, reduce costs, and shorten lead times, which means faster service and better products for you.

SSP Industry Standard Products
Made Better

TABLE of CONTENTS

QC Series Introduction	3	QC Plugs & Caps	8
QC Features	3	QC How to Order	9
QC Materials of Construction	4	QF Series Introduction	10
QC Temperature and Pressure Ratings ..	4	QF Materials of Construction	11
QC Part Numbers and Dimensions Table .	5	QF Plugs & Caps	11
QC Bodies	6	QF Stems	12
QC Stem & Body Keys	7	QF Bodies	13
		QF How to Order	14

QC Series

SSP Quick Connects are a convenient solution for easily connecting and disconnecting fluid lines in grab sample systems, laboratories, and other applications that require frequent connections and disconnections. These connectors offer a leak-tight seal without the need for tools. They are available in various materials such as 316 SS, Alloy 400, Alloy C-276, and Brass, and can withstand a maximum working pressure of 3000 psig (206 bar) and temperatures ranging from -15 to 350° F. The Quick Connects feature different coupling types including DESO (Double End Shut Off), SESO (Single End Shut Off), and full flow, and can be connected to Duolok®, Unilok®, Griplok® tube fittings, and NPT pipe end connections. Additionally, they come with stem plugs and body caps to protect against damage and contamination. The push-to-connect design eliminates the need for tools, and keyed couplings are employed to differentiate between different media and avoid accidental connections to the wrong media. Choose Quick Connects for your specific applications.

Product Design

- 1 **AUTOMATIC COUPLING**
 - Push to connect design means no tools are required
- 2 **LOCKING BALL DESIGN**
 - Easily connects & disconnects
- 3 **O-RING SEAL**
 - O-ring positioned to minimize spillage
- 4 **VALVE STOPS**
 - Prevent flow checking during flow surges

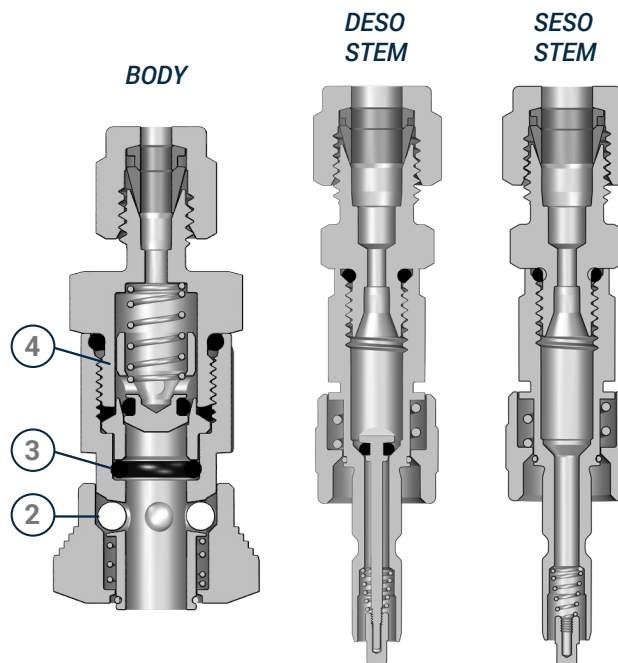

QC Series Materials of Construction

ID	Component	316 SS	Brass
1	Sleeve Snap Ring	316 SS	316 SS
2	Sleeve	316 SS	Brass
3	Sleeve Spring	316 SS	316 SS
4	Locking Balls	316 SS	316 SS
5	Body *	316 SS	Brass
6	Stem O-Ring *	Fluorocarbon FKM	Nitrile
7	Insert *	316 SS	Brass
8	Insert O-Ring *	Fluorocarbon FKM	Nitrile
9	Valve O-Ring *	Fluorocarbon FKM	Nitrile
10	Valve *	316 SS	Brass
11	Valve Spring *	316 SS	316 SS
12	Adapter O-Ring *	Fluorocarbon FKM	Nitrile
13	Adapter *	316 SS	Brass
14	Sleeve Snap Ring	316 SS	316 SS
15	Sleeve	316 SS	Brass
16	Sleeve Spring	316 SS	316 SS
17	Valve Cap *	316 SS	Brass
18	Valve Spring *	316 SS	316 SS
19	Stem Body *	316 SS	Brass
20	Valve O-Ring *+	Fluorocarbon FKM	Nitrile
21	Valve *+	316 SS	Brass
22	Adapter O-Ring *	Fluorocarbon FKM	Nitrile
23	Adapter *	316 SS	Brass
	Lubricants	Silicone and PTFE Based	Silicone and PTFE Based

*Wetted Components

+DESO only

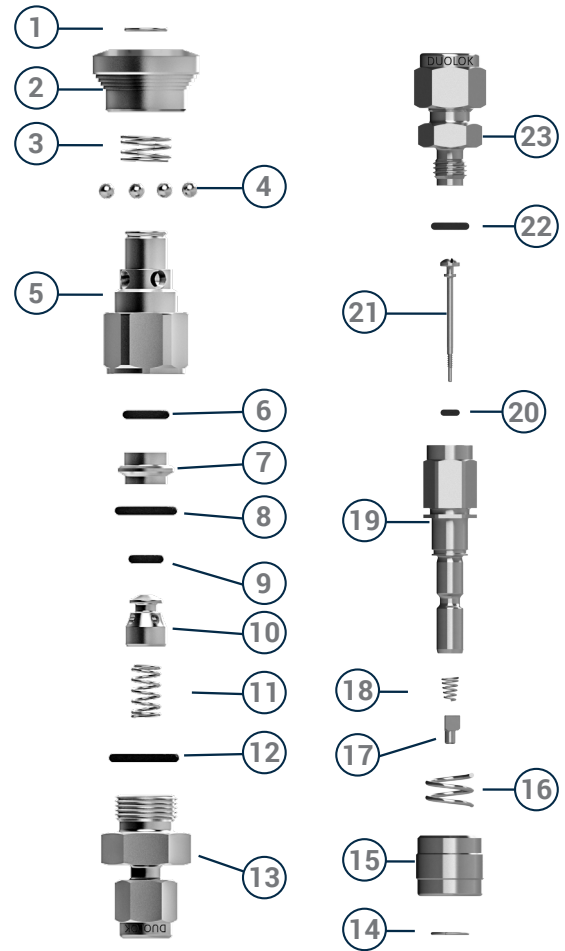

QC Series Temperature - Pressure

Temperature °F	316 SS			Brass		
	QC4	QC6	QC8	QC4	QC6	QC8
	Pressure Rating psig					
Coupled						
70	3000	1500	750	2000	1000	500
250	-	-	-	250	250	250
400	500	400	300	300	300	300
Uncoupled and During Coupling & Uncoupling						
70	250	250	250	250	250	250

Part Numbers and Dimensions

Stems

End Connection		Basic Ordering Number	Dimensions in. (mm)			
Inlet/Outlet	Size		Connector Size	A	B	C
Fractional Tube Fitting	DESO	QC4-D-D2	1/8	2.82 (71.63)	0.62 (15.75)	7/16 (11.11)
		QC4-D-D4	1/4	2.94 (74.68)	0.62 (15.75)	1/12 (12.7)
		QC6-D-D6	3/8	3.05 (77.47)	0.74 (18.8)	5/8 (15.88)
		QC8-D-D8	1/2	3.27 (83.06)	0.87 (22.1)	13/16 (20.64)
Female NPT	DESO	QC4-D-2PF	1/8	2.55 (64.77)	0.62 (15.75)	9/16 (14.29)
		QC4-D-4PF	1/4	2.74 (69.6)	0.62 (15.75)	3/4 (19.05)
		QC6-D-4PF	1/4	2.76 (70.1)	0.74 (18.8)	3/4 (19.05)
		QC6-D-6PF	3/8	2.83 (71.88)	0.74 (18.8)	7/8 (22.23)
		QC8-D-8PF	1/2	3.37 (85.6)	0.87 (22.1)	1-1/16 (26.99)
Male NPT	DESO	QC4-D-2PM	1/8	2.61 (66.29)	0.62 (15.75)	7/16 (11.11)
		QC4-D-4PM	1/4	2.82 (71.63)	0.62 (15.75)	9/16 (14.29)
		QC6-D-4PM	1/4	2.84 (72.14)	0.74 (18.8)	9/16 (14.29)
		QC6-D-6PM	3/8	2.86 (72.64)	0.74 (18.8)	11/16 (17.46)
		QC8-D-8PM	1/2	3.46 (87.88)	0.87 (22.1)	7/8 (22.23)
Fractional Tube Fitting	SESO	QC4-S-D2	1/8	2.82 (71.63)	0.62 (15.75)	7/16 (11.11)
		QC4-S-D4	1/4	2.94 (74.68)	0.62 (15.75)	1/2 (12.7)
		QC6-S-D6	3/8	3.05 (77.47)	0.74 (18.8)	5/8 (15.88)
		QC8-S-D8	1/2	3.27 (83.06)	0.87 (22.1)	13/16 (20.64)
Female NPT	SESO	QC4-S-2PF	1/8	2.55 (64.77)	0.62 (15.75)	9/16 (14.29)
		QC4-S-4PF	1/4	2.74 (69.6)	0.62 (15.75)	3/4 (19.05)
		QC6-S-4PF	1/4	2.76 (70.1)	0.74 (18.8)	3/4 (19.05)
		QC6-S-6PF	3/8	2.83 (71.88)	0.74 (18.8)	7/8 (22.23)
		QC8-S-8PF	1/2	3.37 (85.6)	0.87 (22.1)	1-1/16 (26.99)
Male NPT	SESO	QC4-S-2PM	1/8	2.61 (66.29)	0.62 (15.75)	7/16 (11.11)
		QC4-S-4PM	1/4	2.82 (71.63)	0.62 (15.75)	9/16 (14.29)
		QC6-S-4PM	1/4	2.84 (72.14)	0.74 (18.8)	9/16 (14.29)
		QC6-S-6PM	3/8	2.86 (72.64)	0.74 (18.8)	11/16 (17.46)
		QC8-S-8PM	1/2	3.46 (87.88)	0.87 (22.1)	7/8 (22.23)

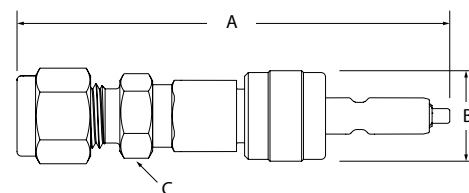
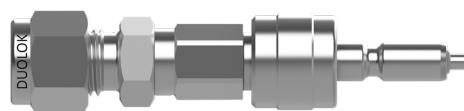

Bodies

Part Numbers and Dimensions

End Connection	Basic Ordering Number	Dimensions in. (mm)			
Inlet/Outlet		Connector Size	A	B	C
Fractional Tube Fitting	QC4-B-D2	1/8	2.02 (51.31)	2.02 (51.31)	5/8 (15.88)
	QC4-B-D4	1/4	2.11 (53.59)	2.11 (53.59)	5/8 (15.88)
	QC6-B-D6	3/8	2.38 (60.45)	2.38 (60.45)	3/4 (19.05)
	QC8-B-D8	1/2	3.30 (83.82)	3.30 (83.82)	5/16 (23.81)
Female NPT	QC4-B-2PF	1/8	1.94 (49.28)	1.94 (49.28)	5/8 (15.88)
	QC4-B-4PF	1/4	2.13 (54.1)	2.13 (54.1)	3/4 (19.05)
	QC6-B-4PF	1/4	2.34 (59.44)	2.34 (59.44)	3/4 (19.05)
	QC6-B-6PF	3/8	2.41 (61.21)	2.41 (61.21)	7/8 (22.23)
	QC8-B-8PF	1/2	2.96 (75.18)	2.96 (75.18)	1-1/16 (26.99)
Male NPT	QC4-B-2PM	1/8	1.80 (45.72)	1.80 (45.72)	5/8 (15.88)
	QC4-B-4PM	1/4	1.98 (50.29)	1.98 (50.29)	5/8 (15.88)
	QC6-B-4PM	1/4	2.20 (55.88)	2.20 (55.88)	3/4 (19.05)
	QC6-B-6PM	3/8	2.20 (55.88)	2.20 (55.88)	3/4 (19.05)
	QC8-B-8PM	1/2	2.56 (65.02)	2.56 (65.02)	5/16 (23.81)

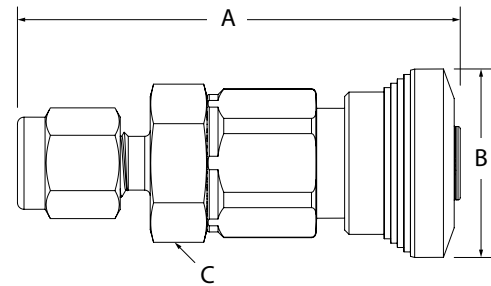
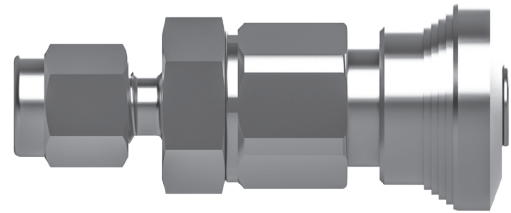

Stem Keys

Quick Connect Key Numbers and Stem Sleeve Outside Diameters			
Key Number and Color	QC4	QC6	QC8
	Ø Stem Sleeve in. (mm)	Ø Stem Sleeve in. (mm)	Ø Stem Sleeve in. (mm)
K1 Black	0.82 (20.83)	0.99 (25.15)	1.11 (28.19)
K2 Orange	0.85 (21.59)	1.02 (25.91)	1.14 (28.96)
K3 Green	0.88 (22.35)	1.05 (26.67)	1.17 (29.72)
K4 Yellow	0.91 (23.11)	1.08 (27.43)	1.20 (30.48)
K5 Blue	0.94 (23.88)	1.11 (28.19)	1.23 (31.24)
K6 White	0.97 (24.64)	1.14 (28.96)	1.26 (32)
K7 Purple	1.00 (25.4)	1.17 (29.72)	1.29 (32.77)
K8 Brown	1.03 (26.16)	1.2 (30.48)	1.32 (33.53)

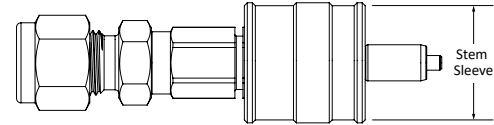
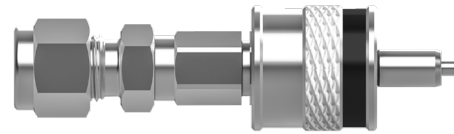

Body Keys

Quick Connect Key Numbers and Body Sleeve Outside Diameters			
Key Number and Color	QC4	QC6	QC8
	Ø Body Sleeve in. (mm)	Ø Body Sleeve in. (mm)	Ø Body Sleeve in. (mm)
K1 Black	0.96 (24.38)	1.13 (28.7)	1.26 (32)
K2 Orange	0.99 (25.15)	1.16 (29.46)	1.29 (32.77)
K3 Green	1.02 (25.91)	1.19 (30.23)	1.32 (33.53)
K4 Yellow	1.05 (26.67)	1.22 (30.99)	1.35 (34.29)
K5 Blue	1.08 (27.43)	1.25 (31.75)	1.38 (35.05)
K6 White	1.11 (28.19)	1.28 (32.51)	1.41 (35.81)
K7 Purple	1.14 (28.96)	1.31 (33.27)	1.44 (36.58)
K8 Brown	1.17 (29.72)	1.35 (34.29)	1.47 (37.34)

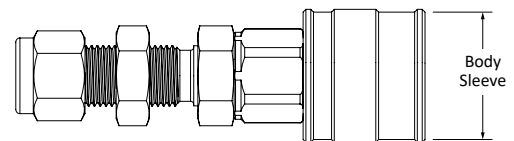
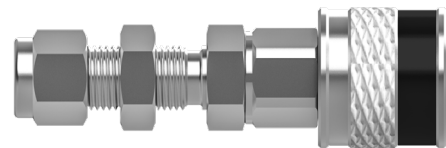

Plugs and Caps

Stem Plugs					
Series	Basic Ordering Number	Body Size	A in. (mm)	B in. (mm)	C in. (mm)
QC4	QC4-SP	1/4	2.25 (57.15)	0.62 (15.75)	9/16 (14.29)
QC6	QC6-SP	3/8	2.47 (62.74)	0.74 (18.8)	11/16 (17.46)
QC8	QC8-SP	1/2	3.38 (85.85)	0.87 (22.1)	7/8 (22.23)

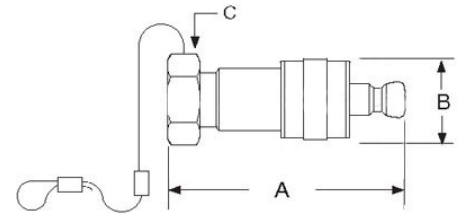

Keyed Stem Plugs					
Series	Basic Ordering Number	Body Size	A in. (mm)	B in. (mm)	C in. (mm)
QC4	QC4-SP	1/4	2.25 (57.15)	*	9/16 (14.29)
QC6	QC6-SP	3/8	2.47 (62.74)	*	11/16 (17.46)
QC8	QC8-SP	1/2	3.38 (85.85)	*	7/8 (22.23)

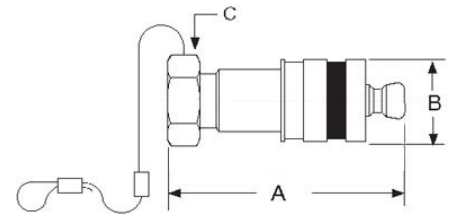

* See page 7 for full chart

Body Caps					
Series	Basic Ordering Number	Body Size	A in. (mm)	B in. (mm)	C in. (mm)
QC4	QC4-BC	1/4	1.42 (36.07)	0.86 (21.84)	9/16 (14.29)
QC6	QC6-BC	3/8	1.63 (41.4)	0.98 (24.89)	11/16 (17.46)
QC8	QC8-BC	1/2	2.01 (51.05)	1.21 (30.73)	7/8 (22.23)

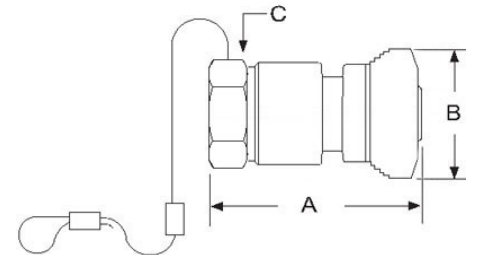

Keyed Body Caps					
Series	Basic Ordering Number	Body Size	A in. (mm)	B in. (mm)	C in. (mm)
QC4	QC4-BC	1/4	1.42 (36.07)	*	9/16 (14.29)
QC6	QC6-BC	3/8	1.63 (41.4)	*	11/16 (17.46)
QC8	QC8-BC	1/2	2.01 (51.05)	*	7/8 (22.23)

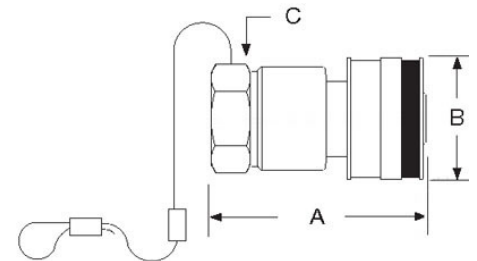

* See page 7 for full chart

How to Order

Ordering Instructions

- 1 Select the basic ordering number from the Part Numbers and Dimensions table based on the end connections and orifice size for the valve. Example: **QC4-D-D4-316**
- 2 Select the body or stem designator, then add it to the base part number. Example: **QC4-D-D4-316**
- 3 Select the inlet type and size designator, then add it the part number. Example: **QC4-D-D4-316**
- 4 Select the material designator, then add it the part number. Example: **QC4-D-D4-316**
- 5 Select the valve designator, then add it the part number. Example: **QC4-D-D4-316-FF**
- 6 Select the O-ring designator. Example: **QC4-D-D4-316-KZ**
- 7 Select the color key to prevent accidental intermixing of different lines. Example: **QC4-D-D4-316-KZ-K1**

Stems

A	B	C	D	E	F
QC4	-D	-D4	-316	-KZ	-K1

Caps & Plugs

A	B	D	F
QC4	-SP	-316	-K1

Bodies

A	B	C	D	E	F	G
QC4	-B	-D4	-316	-FF	-KZ	-K1

A STEM/BODY SIZE

QC4	1/4 Connector size
QC6	3/8 Connector size
QC8	1/2 Connector size

B CONNECTION TYPE

-B	Body
-D	DESO (Double end shutoff)
-S	SESO (Single end shutoff)
-BC	Body Cap
-SP	Stem Plug

C INLET TYPE & SIZE

-D2	Duolok Tube Fitting 1/8 in.
-D4	Duolok Tube Fitting 1/4 in.
-D6	Duolok Tube Fitting 3/8 in.
-D8	Duolok Tube Fitting 1/2 in.
-2PF	Female NPT 1/8 in.
-4PF	Female NPT 1/4 in.
-6PF	Female NPT 3/8 in.
-8PF	Female NPT 1/2 in.
-2PM	Male NPT 1/8 in.
-4PM	Male NPT 1/4 in.
-6PM	Male NPT 3/8 in.
-8PM	Male NPT 1/2 in.

D MATERIAL

-316	316 SS
-B	Brass

E BODY VALVE TYPE

(Blank)	Valved
-FF	Full Flow*

G COLOR KEYS

-K1	Black
-K2	Orange
-K3	Green
-K4	Yellow
-K5	Blue
-K6	White
-K7	Purple
-K8	Brown

F O-RINGS ALPHABETICAL ORDER

(Blank)	Fluorocarbon FKM
-BN	Nitrile Buna N
-KZ	Kalrez® FFKM
-EP	Ethylene Propylene

Kalrez® is a registered trademark of DuPont Performance Elastomers.

* Full Flow coupler bodies are non-valved. Use with SESO Stems only.

QF Series

QF Series quick connects provide full flow connections for applications having up-stream and down-stream shut-off capabilities. Typical applications for quick connect are venting, draining, mixing and transfer applications. These connectors provide a maximum working pressure (MAWP) of up to 6000 psig and can operate within a temperature range of -40 to 350° F. The Full Flow Quick Connects feature a flow coefficient ranging from 1.7 to 45, ensuring efficient fluid flow. They are available in sizes ranging from ¼ to 1 inch and are constructed using 316 SS material, known for its corrosion resistance and durability. When your applications demand complete full flow connections, then select QF Quick Connects for optimal performance.



Design

- 1 **COMPACT SIZE**
- 2 **FULL BIDIRECTIONAL FLOW**
- 3 **LOCKING BALL DESIGN**
 - Easy connections and disconnections
- 4 **SINGLE O-RING SEAL**
 - Easily replaced without disassembling the body
- 5 **OPTIONS**
 - Stem Caps and Body Plugs

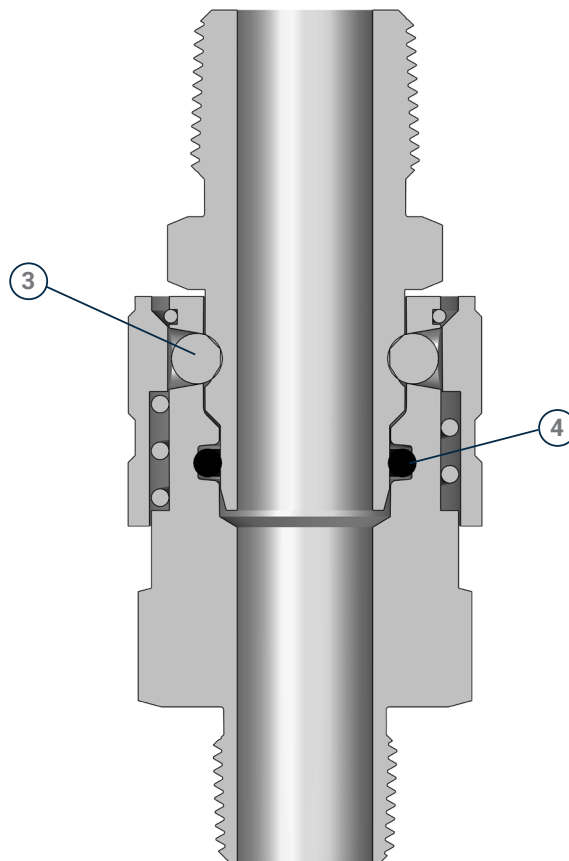

QF Series Materials of Construction

Component		316 SS	Brass
1	Body	316 SS	Brass
2	Locking Balls	316 SS	316 SS
3	O-Ring	Fluorocarbon FKM	Nitrile
4	Spring	302 SS / 316 SS	302 SS / 316 SS
5	Sleeve	316 SS	Brass
6	Snap Ring	302 SS / 316 SS	302 SS / 316 SS
7	Stem	316 SS	Brass
Lubricants		Silicone and PTFE Based	Silicone and PTFE Based

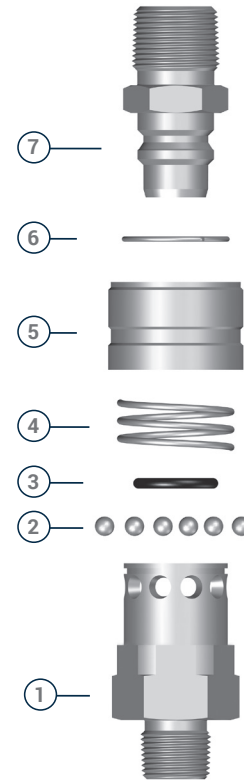

Specifications								
Temperature °F (°C)	316 SS psig (bar)				Brass psig (bar)			
	QF4	QF8	QF12	QF16	QF4	QF8	QF12	QF16
70 (20)	6000 (413)		4000 (275)		4000 (275)	3000 (206)	2000 (137)	
250 (121)	100 (6.8)							
400 (204)								

Caps & Plugs

Use SSP stem plugs and body caps to protect against damage and contaminants when SSP full Flow Quick Connects are uncoupled. Body caps and stem plugs are pressure containing. They can be used to retain system pressure. To order, select a basic ordering number and add the suffix -316 for stainless steel or -B for brass.

Example: QF4-SP-316

Series	Basic Ordering Number	
	Stem Plugs	Body Caps
QF4	QF4-SP	QF4-BC
QF8	QF8-SP	QF8-BC
QF12	QF12-SP	QF12-BC
QF16	QF16-SP	QF16-BC

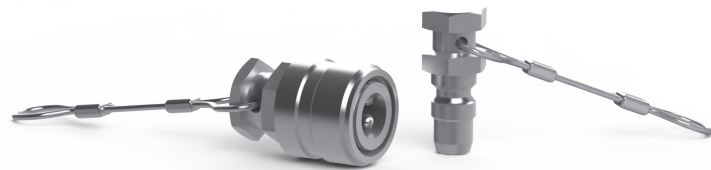

Materials	
Component	Material
Protector	316 SS
Lanyard	302 SS
Lanyard Clamp	304 SS

Stems

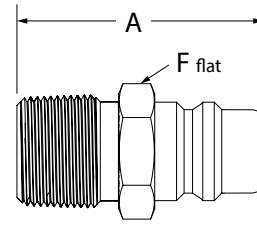
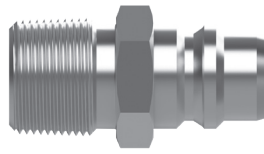

End Connection		Basic Ordering Number	Dimensions in. (mm)			
Inlet/Outlet	Size		Flow Coefficient (CV)	min Orifice	A	F
Fractional Tube Fitting	1/4	QF4-S-D4	2.2	0.19 (4.8)	1.77 (45.0)	9/16 (14.3)
	3/8	QF4-S-D6	2.8	0.24 (6.1)	1.77 (45.0)	11/16 (17.5)
	3/8	QF8-S-D6	2.9	0.28 (7.1)	1.88 (47.8)	7/8 (22.2)
	1/2	QF8-S-D8	13	0.41 (10.4)	1.99 (50.5)	7/8 (22.2)
	3/4	QF12-S-D12	26.0	0.62 (15.7)	2.15 (54.6)	1 1/16 (27.0)
	1	QF16-S-D16	45.0	0.88 (22.4)	2.45 (62.2)	1 3/8 (34.9)
Metric Tube Fitting	6	QF4-S-DM6	2.2	0.19 (4.8)	1.77 (45.0)	9/16 (14.3)
Female NPT	1/4	QF4-S-4PF	1.7	0.24 (6.1)	1.60 (40.6)	3/4 (0.75)
	3/8	QF4-S-6PF	1.7	0.24 (6.1)	1.67 (42.4)	7/8 (22.2)
	3/8	QF8-S-6PF	7.1	0.47 (11.9)	1.59 (40.4)	1 1/16 (27.0)
	1/2	QF8-S-8PF	11.5	0.50 (12.7)	1.82 (46.2)	1 1/16 (27.0)
	3/4	QF12-S-12PF	23.6	0.72 (18.3)	2.08 (52.8)	1 5/16 (33.3)
	1	QF16-S-16PF	39.0	0.88 (22.4)	2.49 (63.2)	1 5/8 (41.3)
Female ISO Tapered	1/4	QF4-S-4FRT	1.7	0.24 (6.1)	1.60 (40.6)	3/4 (0.75)
	1/2	QF8-S-8FRT	11.5	0.50 (12.7)	1.82 (46.2)	1 1/16 (27.0)
	1	QF16-S-16FRT	39.0	0.88 (22.4)	2.49 (63.2)	1 5/8 (41.3)
Female ISO Parallel	1/4	QF4-S-4FRS	1.7	0.24 (6.1)	1.60 (40.6)	3/4 (0.75)
	1/2	QF8-S-8FRS	11.5	0.50 (12.7)	1.82 (46.2)	1 1/16 (27.0)
Male NPT	1/4	QF4-S-4PM	1.7	0.24 (6.1)	1.59 (40.4)	9/16 (14.3)
	3/8	QF4-S-6PM	1.7	0.24 (6.1)	1.59 (40.4)	11/16 (17.5)
	3/8	QF8-S-6PM	7.1	0.41 (10.4)	1.65 (41.9)	7/8 (22.2)
	1/2	QF8-S-8PM	11.5	0.50 (12.7)	1.84 (46.7)	7/8 (22.2)
	3/4	QF12-S-12PM	23.6	0.72 (18.3)	2.03 (51.6)	1 1/16 (27.0)
	1	QF16-S-16PM	39.0	0.88 (22.4)	2.35 (59.7)	1 3/8 (34.9)
Male ISO Tapered	1/4	QF4-S-4MRT	1.7	0.24 (6.1)	1.59 (40.4)	9/16 (14.3)
	1/2	QF8-S-8MRT	11.5	0.50 (12.7)	1.84 (46.7)	7/8 (22.2)
	1	QF16-S-16MRT	39.0	0.88 (22.4)	2.35 (59.7)	1 3/8 (34.9)
Male ISO Parallel	1/4	QF4-S-4MRS	1.7	0.24 (6.1)	1.60 (40.6)	3/4 (0.75)
	1/2	QF8-S-8MRS	11.5	0.50 (12.7)	1.82 (46.2)	1 1/16 (27.0)

Bodies

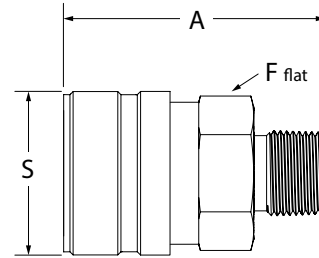
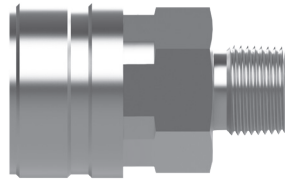

End Connexion		Basic Ordering Number	Dimensions in. (mm)				
Inlet/Outlet	Size		Flow Coefficient (CV)	min Orifice	A	F	S
Fractional Tube Fitting	1/4	QF4-B-D4	2.2	0.19 (4.8)	1.77 (45.0)	9/16 (14.3)	0.87 (22.1)
	3/8	QF4-B-D6	2.8	0.24 (6.1)	1.77 (45.0)	11/16 (17.5)	0.87 (22.1)
	3/8	QF8-B-D6	2.9	0.28 (7.1)	1.88 (47.8)	7/8 (22.2)	1.30 (33.0)
	1/2	QF8-B-D8	13	0.41 (10.4)	1.99 (50.5)	7/8 (22.2)	1.30 (33.0)
	3/4	QF12-B-D12	26.0	0.62 (15.7)	2.15 (54.6)	1 1/16 (27.0)	1.66 (42.2)
	1	QF16-B-D16	45.0	0.88 (22.4)	2.45 (62.2)	1 3/8 (34.9)	1.88 (47.8)
Metric Tube Fitting	6	QF4-B-DM6	2.2	0.19 (4.8)	1.77 (45.0)	9/16 (14.3)	0.87 (22.1)
Female NPT	1/4	QF4-B-4PF	1.7	0.24 (6.1)	1.60 (40.6)	3/4 (0.75)	0.87 (22.1)
	3/8	QF4-B-6PF	1.7	0.24 (6.1)	1.67 (42.4)	7/8 (22.2)	0.87 (22.1)
	3/8	QF8-B-6PF	7.1	0.47 (11.9)	1.59 (40.4)	1 1/16 (27.0)	1.30 (33.0)
	1/2	QF8-B-8PF	11.5	0.50 (12.7)	1.82 (46.2)	1 1/16 (27.0)	1.30 (33.0)
	3/4	QF12-B-12PF	23.6	0.72 (18.3)	2.08 (52.8)	1 5/16 (33.3)	1.66 (42.2)
	1	QF16-B-16PF	39.0	0.88 (22.4)	2.49 (63.2)	1 5/8 (41.3)	1.88 (47.8)
Female ISO Tapered	1/4	QF4-B-4FRT	1.7	0.24 (6.1)	1.60 (40.6)	3/4 (0.75)	0.87 (22.1)
	1/2	QF8-B-8FRT	11.5	0.50 (12.7)	1.82 (46.2)	1 1/16 (27.0)	1.30 (33.0)
	1	QF16-B-16FRT	39.0	0.88 (22.4)	2.49 (63.2)	1 5/8 (41.3)	1.88 (47.8)
Female ISO Parallel	1/4	QF4-B-4FRS	1.7	0.24 (6.1)	1.60 (40.6)	3/4 (0.75)	0.87 (22.1)
	1/2	QF8-B-8FRS	11.5	0.50 (12.7)	1.82 (46.2)	1 1/16 (27.0)	1.30 (33.0)
Male NPT	1/4	QF4-B-4PM	1.7	0.24 (6.1)	1.59 (40.4)	9/16 (14.3)	0.87 (22.1)
	3/8	QF4-B-6PM	1.7	0.24 (6.1)	1.59 (40.4)	11/16 (17.5)	0.87 (22.1)
	3/8	QF8-B-6PM	7.1	0.41 (10.4)	1.65 (41.9)	7/8 (22.2)	1.30 (33.0)
	1/2	QF8-B-8PM	11.5	0.50 (12.7)	1.84 (46.7)	7/8 (22.2)	1.30 (33.0)
	3/4	QF12-B-12PM	23.6	0.72 (18.3)	2.03 (51.6)	1 1/16 (27.0)	1.66 (42.2)
	1	QF16-B-16PM	39.0	0.88 (22.4)	2.35 (59.7)	1 3/8 (34.9)	1.88 (47.8)
Male ISO Tapered	1/4	QF4-B-4MRT	1.7	0.24 (6.1)	1.59 (40.4)	9/16 (14.3)	0.87 (22.1)
	1/2	QF8-B-8MRT	11.5	0.50 (12.7)	1.84 (46.7)	7/8 (22.2)	1.30 (33.0)
	1	QF16-B-16MRT	39.0	0.88 (22.4)	2.35 (59.7)	1 3/8 (34.9)	1.88 (47.8)
Male ISO Parallel	1/4	QF4-B-4MRS	1.7	0.24 (6.1)	1.60 (40.6)	3/4 (0.75)	0.87 (22.1)
	1/2	QF8-B-8MRS	11.5	0.50 (12.7)	1.82 (46.2)	1 1/16 (27.0)	1.30 (33.0)

Ordering Instructions

- 1 Select the basic ordering number from the Part Numbers and Dimensions table based on the end connections and orifice size for the valve. *Example: QF4-D-D4-316*
- 2 Select the body or stem designator, then add it to the base part number. *Example: QF4-D-D4-316*
- 3 Select the inlet type and size designator, then add it the part number. *Example: QF4-D-D4-316*
- 4 Select the material designator, then add it the part number. *Example: QF4-D-D4-316*
- 5 Select the O-ring designator. *Example: QF4-D-D4-316-KZ*
- 6 Select the color key to prevent accidental intermixing of different lines. *Example: QF4-D-D4-316-KZ-K1*

Stems

A	B	C	D	E
QF4	-S	-D4	-316	-KZ

Caps & Plugs

A	B	D
QF4	-SP	-316

Bodies

A	B	C	D	E
QF4	-B	-D4	-316	-KZ

<p>A STEM/BODY SIZE</p> <p>QF4 1/4 Connector size QF8 1/2 Connector size QF12 3/4 Connector size QF16 1" Connector size</p> <p>D MATERIAL</p> <p>-316 316 SS -B Brass</p> <p>E O-RINGS ALPHABETICAL ORDER</p> <p>(Blank) Fluorocarbon FKM -BN Nitrile Buna N -KZ Kalrez® FFKM -EP Ethylene Propylene</p>	<p>B CONNECTION TYPE</p> <p>-B Body -S Stem -BC Body Cap -SP Stem Plug</p>
---	---

C INLET TYPE & SIZE	
-D2 Duolok Tube Fitting 1/8 in.	-16FRT Female ISO Tapered 1 in.
-D4 Duolok Tube Fitting 1/4 in.	-4FRS Female ISO Parallel 1/4 in
-D6 Duolok Tube Fitting 3/8 in.	-8FRS Female ISO Parallel 1/2 in
-D8 Duolok Tube Fitting 1/2 in.	-2PM Male NPT 1/8 in.
-D12 Duolok Tube Fitting 3/4 in.	-4PM Male NPT 1/4 in.
-D16 Duolok Tube Fitting 1 in.	-6PM Male NPT 3/8 in.
-2PF Female NPT 1/8 in.	-8PM Male NPT 1/2 in.
-4PF Female NPT 1/4 in.	-12PM Male NPT 3/4 in.
-6PF Female NPT 3/8 in.	-16PM Male NPT 1 in.
-8PF Female NPT 1/2 in.	-4FRT Male ISO Tapered 1/4 in.
-12PF Female NPT 3/4 in.	-8FRT Male ISO Tapered 1/2 in.
-16PF Female NPT 1 in.	-16FRT Male ISO Tapered 1 in.
-4FRT Female ISO Tapered 1/4 in.	-4MRS Male ISO Parallel 1/4 in.
-8FRT Female ISO Tapered 1/2 in.	-8MRS Male ISO Parallel 1/2 in.

Kalrez® is a registered trademark of DuPont Performance Elastomers.

More SSP Products



Tube Fittings

Duolok and Griplok two-ferrule and Unilok® single ferrule tube fittings provide leak-tight installation even when intermixed with Swagelok®, Hoke Gyrolok® and Parker CPI™ fittings.



Valves

The SSP valve offering includes ball, check, metering, needle, toggle, plug, bleed, and purge valves for pressures up to 10,000 psig.



Tubing

SSP offers straight and coiled seamless 316 stainless steel instrumentation tubing for instrumentation, process and utility applications.



Pipe Fittings

TruFit and TruFit 10K pipe fittings are available in a wide range of weld, threaded and flared connections.



Filters

SSP in-line and tee-type filters trap particles to clean sample fluids and protect sensitive process and analytical instrumentation components and equipment.



Tools & Accessories

SSP TurnPro professional hand tools, power tools and installation training make quality tube system installation faster and easier.



Quick Connects

SSP offers single-end shutoff, double-end shutoff, and full-flow quick connects for instrumentation and process applications.



SSP

Founded 1926

Privately owned, third generation business

Modern single-site vertically integrated manufacturing facility

DFARS-compliant raw material

ISO 9001 quality management system

Limited Lifetime Warranty



8250 Boyle Parkway • Twinsburg, OH 44087
330-425-4250 • www.mySSP.com