



# Alloy 400/405 & C-276



## Instrumentation Fittings & Valves

Duolok Tube Fittings

TruFit Pipe Fittings

Valves

Alloy 400

Alloy C-276

[www.mySSP.com](http://www.mySSP.com)





At SSP, we are proud to be an American manufacturing success story.

**100% of our products are made in America.** All of our manufacturing is performed in our 165,000 sq. ft. facility located near Cleveland, Ohio. Our facility is the largest vertically integrated, single-site operation in the industry. In addition to manufacturing and assembly, we have closed die forging, tool & die design, product engineering and testing operations under the same roof with customer service and management.

**Made in America is good business.** Not only do we make everything in America, we use American suppliers too. Buying American allows us to have better quality control and a more reliable supply chain. We can work more closely within our walls and with our suppliers to improve quality, reduce costs, and shorten lead times, which means faster service and better products for you.

**Support where it counts.** SSP products and services are supported by more than 4000 people and 350 distributor locations around the globe. For a distributor near you, contact SSP Customer Service or visit [www.mySSP.com/distributors](http://www.mySSP.com/distributors).

**SSP** Industry Standard Products.  
*Made Better.*



# TABLE of CONTENTS

Introduction .....	4	<b>Check Valves</b> .....	38
<b>Tube Fittings</b> .....	6	– CH Series Check Valves .....	38
Installation Instructions .....	7	– How to Order CH Series Check Valves .....	40
How to Order Tube Fittings .....	10	– 4000 Series Check Valves .....	41
Allowable Working Pressure .....	11	– How to Order 4000 Series Check Valves .....	42
Selection Guide .....	12	<b>Ball Valves</b> .....	43
<b>Pipe Fittings</b> .....	24	– EB Series Ball Valves .....	43
– How to Order .....	27	– How to Order EB Series Ball Valves .....	46
<b>Needle Valves</b> .....	29	– FB Series Ball Valves .....	49
– 100 & 600 Series Needle Valves .....	29	– How to Order FB Series Ball Valves .....	52
– How to Order 100 & 600 Series Needle Valves .....	31	<b>Quick Connects</b> .....	53
– LN Series Needle Valves .....	33	– QC Series Quick Connects .....	53
– How to Order LN Series Needle Valves .....	36	– How to Order QC Series Quick Connects .....	55

# Introduction

## Quality

SSP's Quality System has been certified to conform to the ISO 9001:2015 Quality Standard. Achievement of this prestigious status further confirms SSP's continuing commitment to quality which is reflected throughout the company in its personnel, policies, equipment, products and service. In addition, all SSP products are manufactured to technical design specifications and rigid quality control standards.

**Process Control** techniques are employed within the manufacturing process to supply timely, meaningful feedback to the production team. Continual process monitoring and equipment control provide the necessary manufacturing quality for SSP instrumentation grade tube fittings.

## Packaging

SSP products are individually bagged to assure the highest levels of quality, safety and cleanliness. The protective bags eliminate contamination from entering the fitting prior to its use, and help to retain integrity.

As long as an SSP product is in its original protective bag, it is identified as factory new, completely assembled and ready for installation. Additionally, for efficient product identification and storage, the SSP products are packaged in boxes that have labels which include the part number, product description and box quantity.



## Materials

SSP sources raw material only from domestic or DFARS compliant countries. All raw materials are ordered to meet appropriate ASTM standards.

SSP follows design practices to meet code requirements of the ASME B31.3 Process Piping Code. In addition products are tested to ensure performance meets or exceeds the code calculated data.

**Alloy 400/405** – SSP straight configuration tube fittings are machined from alloy 405 cold finished bar stock and weld fittings are machined from alloy 400, in accordance with ASTM B164. Shape bodies are machined from close grained alloy 400 forgings in accordance with ASTM B564 and ASME SB564. For valve materials, please refer to the specific valve section of this catalog.

**Alloy C276** – SSP straight configuration tube fittings are machined from alloy C276 cold finished bar stock in accordance with ASTM B574. Shape bodies are machined from close grained alloy C276 forgings in accordance with ASTM B564. For valve materials please refer to the specific valve section of this catalog.

Material Standards		
Material	Bar	Forging
Alloy 400	ASTM B164	ASTM B564, ASME SB564
Alloy C-276	ASTM B574	ASTM B564

## Pressure Ratings

Generally, SSP tube fittings are rated for pressures equal to the maximum allowable working pressures of the tubing recommended for use with the fittings. However, it is important to note that many specially designed fittings, bored-through fittings, fittings having AN, O-Seal and SAE/MS integral ends may have lower pressure ratings than that of the tubing. (See Page 11)

## Temperature Factors

SSP tube fittings function reliably in applications ranging from cryogenic temperatures to high temperature bake out with the tube fitting material as the limiting factor. It is important to note that elevated temperatures will reduce the maximum working pressure capability of the tubing system.

## Lifetime Warranty

SSP tube fittings are covered by a published Lifetime Warranty. Visit [www.mySSP.com](http://www.mySSP.com) for more information.

## Tube Selection

Careful selection and specification of tubing is essential to the performance of a tubing system. When choosing the appropriate tubing material, size and wall thickness, consideration must be given to the system's environment, pressures, temperatures and flows. (See Page 11)

# Tube Fittings

## Design

SSP tube fittings are designed and manufactured to provide a reliable, leak-proof connection in instrumentation and process tubing systems. SSP Duolok tube fittings consist of four precision-machined components:

Figure 01.

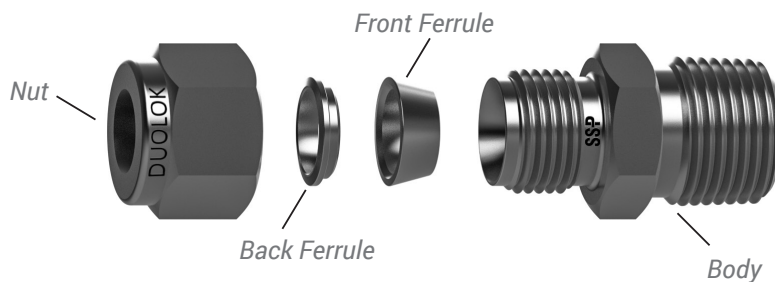

The double ferrule design, with the staged sequential swaging action of the ferrules during make-up, compensates for the variations in tubing materials, hardness, and thickness of the tube wall to provide leak-tight connections in an extensive range of applications.

Additionally, in fulfillment of the design criteria, all SSP tube fitting components are manufactured with stringent tolerances and superior surface finishes under rigorous quality control standards to assure the optimum performance of each component.

## Operation

Through the critical interaction of precision-machined fitting components with the process tube, a leak-tight seal is achieved. The simple geometric rotation of the SSP tube fitting nut provides the axial thrust necessary to swage the ferrules to the outside diameter of the tube. To eliminate any potential stress on an existing system, the tube fittings have been designed to not transmit installation torque from the tube fittings to the tubing.

During the rotary movement of the nut, the internal surface of the nut meets with the rear surface of the back ferrule to axially move the back ferrule forward against the rear angle of the front ferrule. Simultaneously, the front ferrule is driven forward into the angular section of the fitting body where the desired “lift to seal” action of the front ferrule occurs. The back ferrule “locks” on the outside diameter of the tube to complete the sealing action and secure the tube within the fitting.

The resulting “engineered gap” between the front and back ferrule is designed to help compensate for exposure to system variables such as vibration, pressure pulsation and thermal expansion/contraction.

# Installation Instructions

## Initial Installation

- SSP tube fittings come individually bagged and completely assembled for immediate use. There is no need for disassembly prior to use. Simply remove the tube fitting from its bag, insert the tube\* until it bottoms in the SSP tube fitting body and then hand tighten the Duolok nut. (See Figure 02.)

**\*Tubing ends should be cut as straight as possible with all O.D. and I.D. burrs removed. Use of a tubing cutter or guide blocks with a hack-saw is recommended.**

Figure 02.

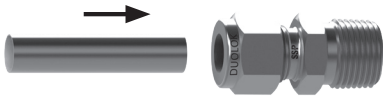

**NOTE: For extreme system applications using high pressures or requiring an extra factor of safety, it may be desirable to use a "common make up starting point" to alleviate the inherent variations in tubing diameters. Installation should begin from a snug position, which is achieved by wrench tightening the Duolok nut until the inserted tubing will not move by hand (approximately 1/8 turn). From this new "snug" starting point, continue with the recommended installation instructions.**

- While holding the fitting body stable with a back-up wrench, scribe the nut for a reference point and wrench tighten the nut 1-1/4 turns for sizes 1/4"-1" or 6mm-25mm and 3/4 turn for sizes 1/16"-3/16" or 3mm-5mm. (See Figures 03 and 04 in the next column.)

**NOTE: For all sizes, tighten plugs (P), machined ferrule end of port connector (PC) and the SSP tube fitting end of the Female AN adapter (ANF) only 1/4 of a turn. Tube fittings in sizes over 25mm and 1in. require the use of the SSP Hydraulic Swaging Tool for installation. Contact your local SSP Distributor for more information.**

## Component Assembly

Should individual component assembly of an SSP tube fitting ever be required, careful attention must be given to the proper sequence and direction of the SSP tube fitting components. (See Figure 07.)

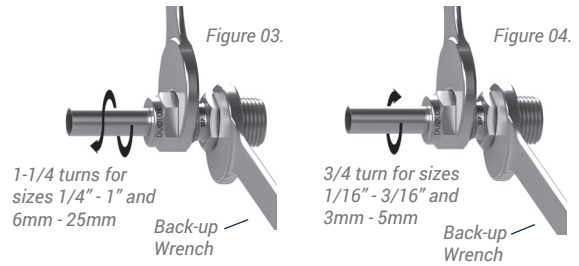

## Reassembly Instructions

- To reassemble an SSP tube fitting connection, simply insert the tubing with the previously coined ferrules and SSP nut into the fitting body until the front ferrule seats within the fitting body, and then tighten the nut by hand. (See Figure 05.)

Figure 05.

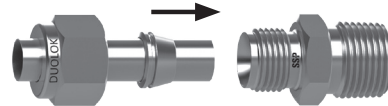

**NOTE: By following proper reassembly procedures, SSP tube fitting connections may be disconnected and reconnected repeatedly.**

- While holding the fitting body stable with a back up wrench, use a wrench to rotate the SSP nut to the fitting's original installation position (approximately 1/4 turn from the hand-tight, snug position) then continue to tighten the SSP nut slightly. (See Figure 06.)

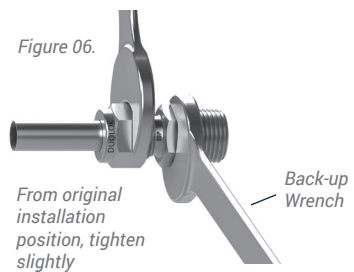
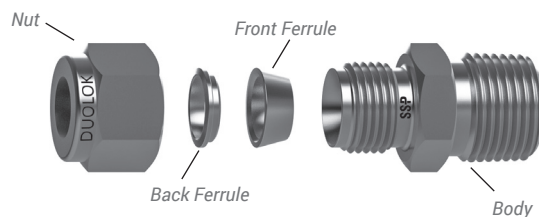

Figure 07.



# Pre-setting

The SSP tube fitting pre-setting tool is used to preset the ferrules on the tubing for subsequent installation in a fitting body. The pre-setting tool can be especially helpful when an installation must be made in a tight space or hard-to-work area. The pre-setting tool allows the major portion of the installation work to occur in a more favorable work setting with only the completion of the installation in the hard-to-work area.

## Pre-setting Instructions

- 1 Secure the pre-setting tool in a vise.
- 2 Remove the protective nut, and assemble the SSP nut and ferrules loosely to the pre-setting tool. Insert the tubing through the nut and ferrules until it bottoms in the pre-setting tool, and then follow the standard SSP tube fitting installation instructions from page 7. (See Figures 08a and 08b.)

Figure 08a.

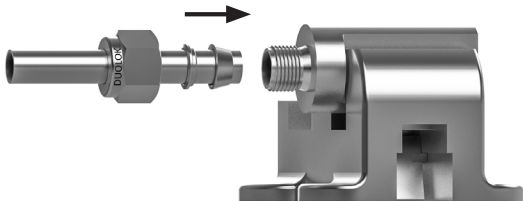
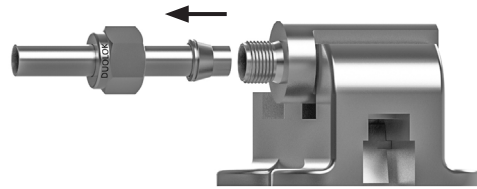

Figure 08b.



- 3 Loosen the nut and remove the tubing with the pre-set SSP tube fitting ferrules and nut from the pre-setting tool. (See Figure 09.)

Figure 09.



- 4 Installation of the tubing, with the pre-set SSP tube fitting ferrules and nut in the appropriate fitting body, can now be made by following the standard reassembly instructions. (See Figures 10a and 10b.)

Figure 10a.

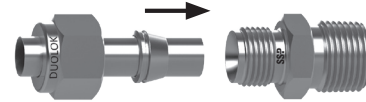
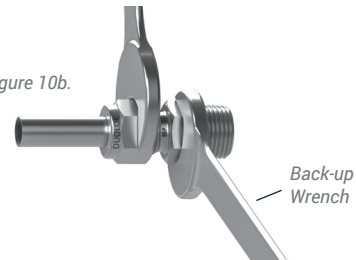

Figure 10b.



- 5 Return the protective nut to the presetting tool.

**NOTE:** To extend the life of a pre-setting tool, lubricate the tool with a lubricant compatible with the system's tubing material, environment and media. Also, at times an over-sized or very soft tubing may tend to stick in the presetting tool after make up. To remove the tubing, gently rock the tubing back and forth. Never turn the tube with pliers or another tool as such action may damage the sealing surfaces.



# Gageability

Each SSP tube fitting component is manufactured with utmost precision to provide the optimum performance interaction of the components during assembly. By maintaining such stringent manufacturing tolerances, SSP tube fittings are considered gageable for sufficient pull-up during initial installation. The SSP tube fitting “Gap Gages” are designed to identify for the installer or inspector, prior to pressurizing a system, that sufficient tightening of the tube fitting has occurred. Gageability provides additional reliability for proper installation and ultimate tube fitting safety and performance.

## Gap Gage Instructions

- ① Follow proper installation instructions (as supplied with the fittings, or published in the SSP tube fittings catalog).
- ② After completion of the installation instructions and prior to pressuring the system, choose the proper size Gap Gage and try to insert it between the fitting’s nut and body hex. (See Figure 11a and 11b.)
- ③ If the Gap Gage will not enter between the fitting’s nut and body hex, no additional tightening is required.
- ④ If the Gap Gage will enter between the fitting’s nut and body hex, additional tightening is required.

**NOTE: Swagelok® Gap Inspection Gages may also be utilized effectively with Duolok tube fittings.**

Figure 11a.



No additional tightening required.

Figure 11b.

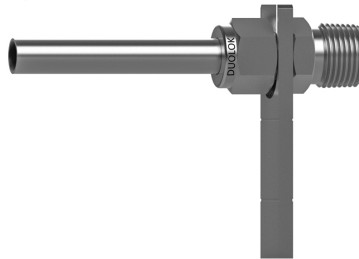

Additional tightening required.

# How to Order

## Ordering Instructions

- ① Select the Instrumentation Material Designator from Chart A. Example: **IHCD4MC2**
- ② Add the SSP Brand Designator ("D" for Duolok). Example: **IHCD4MC2**
- ③ Add the Tube O.D. from Chart C. Example: **IHCD4MC2**
- ④ Add the Type of Tube Fitting from Chart D<sup>1</sup>. Example: **IHCD4MC2**
- ⑤ For a reduced size tube O.D. add a second end connection from Chart C. Example: **IHCD4MC2**
- ⑥ Add options if applicable

### NOTES:

**All Configurations** – Only one size indicator is necessary when all of the connections are the same type and size.

**Straights and Elbows** – Specify the tube end first followed by the smaller tube end or differing type of connection

**Tees and Crosses** – Tees are described by first sizing the run (1 to 2) and then the branch (3).  
Crosses are described by first sizing the run (1 to 2) and then the branch (3 to 4). See Figure 12.

**Specials** – SSP manufactures a wide variety of special application tube fittings.  
Contact your local distributor for details regarding availability of special tube fitting configurations, materials and sizes.

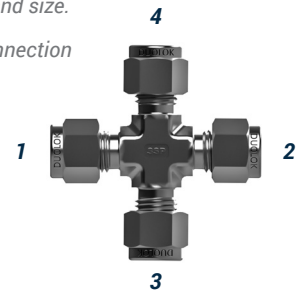

Figure 12.

Basic Part Number					Options	
<b>A</b>	<b>B</b>	<b>C</b>	<b>D<sup>1</sup></b>	<b>C</b>	<b>E</b>	
IM	D	4	MC	2		

<p><b>A MATERIAL</b> IHC Alloy C-276 IM Alloy 400</p> <p><b>B SSP BRAND DESIGNATOR</b> D Duolok Tube Fitting</p> <p><b>C SIZE</b> 2 1/8" 4 1/4" 6 3/8" 8 1/2" 12 3/4"</p>	<p><b>D<sup>1</sup> TUBE FITTING TYPE</b></p> <table border="0"> <tr><td>BU</td><td>Bulkhead Union</td><td>P</td><td>Plug</td></tr> <tr><td>CP</td><td>Cap</td><td>PC</td><td>Port Connector</td></tr> <tr><td>FBT</td><td>Female Branch Tee</td><td>R</td><td>Reducer/Adapter</td></tr> <tr><td>FC</td><td>Female Connector</td><td>RU</td><td>Reducing Union</td></tr> <tr><td>FRT</td><td>Female Run Tee</td><td>U</td><td>Union</td></tr> <tr><td>MBT</td><td>Male Branch Tee</td><td>UCS</td><td>Union Cross</td></tr> <tr><td>MC</td><td>Male Connector</td><td>UE</td><td>Union Elbow</td></tr> <tr><td>MCBT</td><td>Male Connector Bored Through</td><td>UT</td><td>Union Tee</td></tr> <tr><td>MCRS</td><td>Male Connector to ISO Parallel</td><td></td><td></td></tr> <tr><td>ME</td><td>Male Elbow</td><td></td><td></td></tr> </table> <p><b>D<sup>2</sup> COMPONENTS</b></p> <table border="0"> <tr><td>BF</td><td>Back Ferrule</td></tr> <tr><td>BN</td><td>Bulkhead Nut</td></tr> <tr><td>FF</td><td>Front Ferrule</td></tr> <tr><td>FS</td><td>Ferrule Set</td></tr> <tr><td>N</td><td>Nut</td></tr> </table>	BU	Bulkhead Union	P	Plug	CP	Cap	PC	Port Connector	FBT	Female Branch Tee	R	Reducer/Adapter	FC	Female Connector	RU	Reducing Union	FRT	Female Run Tee	U	Union	MBT	Male Branch Tee	UCS	Union Cross	MC	Male Connector	UE	Union Elbow	MCBT	Male Connector Bored Through	UT	Union Tee	MCRS	Male Connector to ISO Parallel			ME	Male Elbow			BF	Back Ferrule	BN	Bulkhead Nut	FF	Front Ferrule	FS	Ferrule Set	N	Nut	<p><b>E OPTIONS</b></p> <table border="0"> <tr><td>-XP98</td><td>Special Cleaning PER ASTM G93 Level C</td></tr> <tr><td>-XP97</td><td>No Lube</td></tr> </table>	-XP98	Special Cleaning PER ASTM G93 Level C	-XP97	No Lube
BU	Bulkhead Union	P	Plug																																																					
CP	Cap	PC	Port Connector																																																					
FBT	Female Branch Tee	R	Reducer/Adapter																																																					
FC	Female Connector	RU	Reducing Union																																																					
FRT	Female Run Tee	U	Union																																																					
MBT	Male Branch Tee	UCS	Union Cross																																																					
MC	Male Connector	UE	Union Elbow																																																					
MCBT	Male Connector Bored Through	UT	Union Tee																																																					
MCRS	Male Connector to ISO Parallel																																																							
ME	Male Elbow																																																							
BF	Back Ferrule																																																							
BN	Bulkhead Nut																																																							
FF	Front Ferrule																																																							
FS	Ferrule Set																																																							
N	Nut																																																							
-XP98	Special Cleaning PER ASTM G93 Level C																																																							
-XP97	No Lube																																																							

## Alloy 400 Tubing

Maximum Allowable Working Pressure (PSIG)

Tube O.D. Size (in.)	Wall Thickness of Tubing (Inches)							
	.028	.035	.049	.065	.083	.095	.109	.120
1/8	8000	10450						
1/4	3750	4800	7000	9800				
3/8		3100	4450	6150	<b>Note:</b> For light gas service, use tubing with wall thickness outside of screened area.			
1/2		2300	3300	4450				
5/8			2700	3000	4000	4600		
3/4			2250	3050	4000	4600		

**Calculation Basis:** Annealed, seamless Monel Alloy 400 tubing ASTM B-165 or equivalent. System temperatures between -20°F and 100°F with allowable stress of 18,700 psi. Ultimate tensile strength of 70,000 psi. Safety factor of 4. Table values are per the ANSI/ASME B 31.3 Code for temperatures from -325°F to only +100°F. Monel derates fast at elevated temperatures. (For more specific working pressure information regarding a particular tubing, consult with the actual manufacturer of the tubing.)

**Suggested Tube Ordering Information:** Specify the outside diameter and wall thickness of annealed, seamless Monel Alloy 400 tubing of ASTM B-165 or equivalent specification. Also specify high quality tubing to be free of scratches, and suited for bending with material hardness not to exceed Rb 75.

## Alloy C276 Tubing

Maximum Allowable Working Pressure (PSIG)

Tube O.D. Size (in.)	Wall Thickness of Tubing (Inches)						
	.020	.028	.035	.049	.065	.083	.095
1/8		8,550	10,200				
1/4		4,000	5,100	7500	10300		
3/8			3,300	4800	6550		
1/2			2,450	3500	4750		

**Note:** For light gas service, use tubing with wall thickness outside of screened area.

**Note:** High quality, fully annealed Alloy C-276 tubing, ASTM B622 or equivalent.  
Hardness not to exceed 100 HRB or 248 HV

## Stress Factors For Determining Tubing Pressure

Ratings At Elevated Temperatures

Temperature Stress Factors			
Temperature		Alloy C276	Alloy 400
°F	°C		
100	38	1.00	1.00
200	93	1.00	0.88
300	149	1.00	0.82
400	204	0.97	0.79
500	260	0.90	0.79
600	316	0.85	0.79
700	371	0.82	0.79
800	427	0.80*	0.76
900	482	0.78*	0.43
1000	538	0.73*	n/a
1200	649	0.37*	n/a













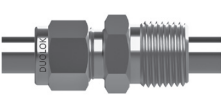







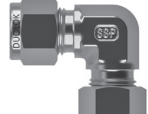

\* The precipitation of chromium carbides potentially resulting in intergranular corrosion may occur when exposed to operating temperatures above 800°F. Consult the factory for further information.

**Instructions:** To determine maximum allowable working pressures for tubing at elevated temperatures, multiply the applicable tube's maximum allowable working pressure by the corresponding temperature stress factor.



# Selection Guide

Our selection guide makes it easy to locate any fitting. Simply turn to the page designated in the lower right-hand corner.

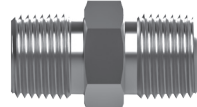
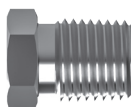

## Tube Fittings

<b>Male Connector</b>  MC 14	<b>Male Connector To ISO Parallel</b>  MCRS 15	<b>Male Connector Bored Through</b>  MCBT 15	<b>Female Connector</b>  FC 16	<b>Cap</b>  CP 16
<b>Plug</b>  P 17	<b>Port Connector</b>  PC 17	<b>Reducer</b>  R 17	<b>Union</b>  U 18	<b>Reducing Union</b>  RU 18
<b>Bulkhead Union</b>  BU 19	<b>Male Elbow</b>  ME 19	<b>Union Elbow</b>  UE 20	<b>Union Tee</b>  UT 20	<b>Union Cross</b>  UCS 21
<b>Female Branch Tee</b>  FBT 21	<b>Female Run Tee</b>  FRT 21	<b>Male Branch Tee</b>  MBT 22	<b>Nut</b>  N 22	<b>Front Ferrule</b>  FF 22
<b>Back Ferrule</b>  BF 23	<b>Ferrule Set</b>  FS 23			

# Pipe Fittings

Hex Long Nipple	Hex Nipple	Pipe Plug	Tee
			
HLN 27	HN 28	PP 28	PT 28



## Needle Valves

100/600 Series	LN Series
	
32	STRAIGHT PATTERN 37

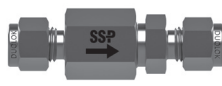

## Check Valves

CH Series	4000 Series
	
40	42

## Ball Valves

EB Series	EB Series	FB Series
		
STRAIGHT PATTERN 48	3-WAY 48	52

## Quick Connects

Stems	Bodies
	
56	56

# Tube Fittings

## Male Connector

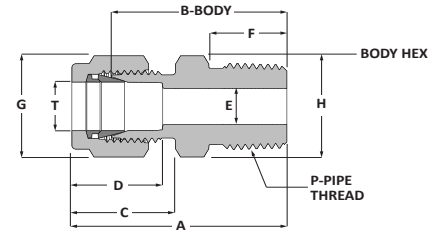
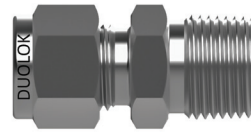

Part #		T (Tube O.D.)	P NPT Male	A	B	C	D	E	F	G	H
<b>ALLOY 405</b>	<b>ALLOY C-276</b>	<b>Fractional (in.)</b>									
IMD2MC2	IHCD2MC2	1/8	1/8	1.20	0.94	0.60	0.50	0.09	0.38	7/16	7/16
IMD2MC4	*	1/8	1/4	1.40	1.14	0.60	0.50	0.09	0.56	7/16	9/16
IMD4MC2	IHCD4MC2	1/4	1/8	1.29	1.00	0.70	0.60	0.17	0.38	9/16	1/2
IMD4MC4	IHCD4MC4	1/4	1/4	1.49	1.20	0.70	0.60	0.19	0.56	9/16	9/16
IMD4MC6	*	1/4	3/8	1.51	1.22	0.70	0.60	0.19	0.56	9/16	11/16
IMD4MC8	IHCD4MC8	1/4	1/2	1.76	1.47	0.70	0.60	0.19	0.75	9/16	7/8
IMD4MC12	*	1/4	3/4	1.82	1.53	0.70	0.60	0.19	0.75	9/16	1 1/16
IMD6MC4	IHCD6MC4	3/8	1/4	1.57	1.28	0.76	0.66	0.28	0.56	11/16	5/8
IMD6MC6	IHCD6MC6	3/8	3/8	1.57	1.28	0.76	0.66	0.28	0.56	11/16	11/16
IMD6MC8	IHCD6MC8	3/8	1/2	1.82	1.53	0.76	0.66	0.28	0.75	11/16	7/8
IMD6MC12	*	3/8	3/4	1.88	1.59	0.76	0.66	0.28	0.75	11/16	1 1/16
IMD8MC4	IHCD8MC4	1/2	1/4	1.71	1.31	0.86	0.90	0.28	0.56	7/8	13/16
IMD8MC8	IHCD8MC8	1/2	1/2	1.93	1.53	0.86	0.90	0.41	0.75	7/8	7/8
IMD8MC12	IHCD8MC12	1/2	3/4	1.99	1.59	0.86	0.90	0.41	0.75	7/8	1-1/16
IMD8MC16	*	1/2	1	2.25	1.85	0.86	0.90	0.41	0.94	7/8	1-3/8
IMD10MC8	*	5/8	1/2	1.93	1.53	0.86	0.96	0.47	0.75	1	15/16
IMD12MC8	*	3/4	1/2	1.99	1.59	0.86	0.96	0.47	0.75	1 1/8	1 1/16
IMD12MC12	*	3/4	3/4	1.99	1.59	0.86	0.96	0.62	0.75	1 1/8	1 1/16
<b>Metric (mm)</b>											
IMDM6MC4	*	6	1/4	37.9	30.5	17.7	15.3	4.8	14.2	14.0	14.0
IMDM12MC8	*	12	1/2	49.0	38.9	22.0	22.8	9.5	19.0	22.0	22.0

\* Contact SSP for availability

# Tube Fittings

## Male Connector To ISO Parallel

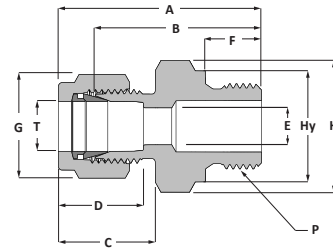
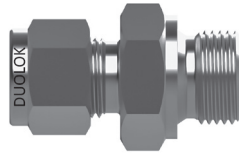

Part #		T (Tube O.D.)	P NPT Male	A	B	C	D	E	F	G	H Hex Flat	Hy
ALLOY 405	ALLOY C-276	Fractional (in.)										
IMD4MCRS4	*	1/4	1/4	1.48	1.19	0.70	0.60	0.19	0.44	9/16	3/4	0.71

\* Contact SSP for availability

## Male Connector Bored Through

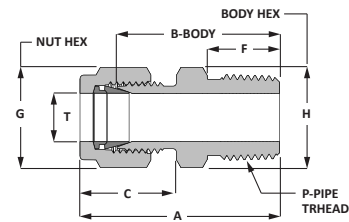

Part #		T (Tube O.D.)	P NPT Male	A	B	C	F	G	H
ALLOY 405	ALLOY C-276	Fractional (in.)							
IMD4MCBT4	IHCD4MCBT4	1/4	1/4	1.49	1.20	0.70	0.56	9/16	9/16
IMD4MCBT6	IHCD4MCBT6	1/4	3/8	1.51	1.22	0.70	0.56	9/16	11/16

# Tube Fittings

## Female Connector

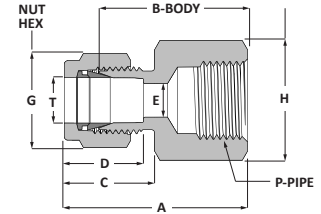
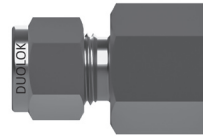

Part #		T (Tube O.D.)	P NPT Female	A	B	C	D	E	G	H
<b>ALLOY 405</b>	<b>ALLOY C-276</b>	<b>Fractional (in.)</b>								
IMD4FC2	*	1/4	1/8	1.23	0.94	0.70	0.60	0.19	9/16	9/16
IMD4FC4	IHCD4FC4	1/4	1/4	1.41	1.12	0.70	0.60	0.19	9/16	3/4
IMD4FC8	*	1/4	1/2	1.67	1.38	0.70	0.60	0.19	9/16	1 1/16
IMD6FC6	*	3/8	3/8	1.54	1.25	0.76	0.66	0.28	11/16	7/8
IMD6FC8	*	3/8	1/2	1.73	1.44	0.76	0.66	0.28	11/16	1 1/16
IMD8FC8	*	1/2	1/2	1.84	1.44	0.86	0.90	0.41	7/8	1 1/16

\* Contact SSP for availability

## Cap

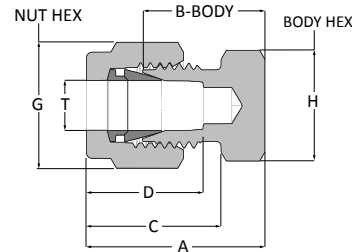
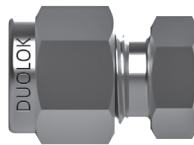

Part #		T (Tube O.D.)	A	B	C	D	G	H	
<b>ALLOY 405</b>	<b>ALLOY C-276</b>	<b>Fractional (in.)</b>							
IMD4CP	IHCD4CP	1/4	0.92	0.63	0.70	0.60	9/16	1/2	
IMD6CP	IHCD6CP	3/8	1.01	0.72	0.76	0.66	11/16	5/8	
IMD8CP	IHCD8CP	1/2	1.15	0.75	0.86	0.90	7/8	13/16	



## Plug

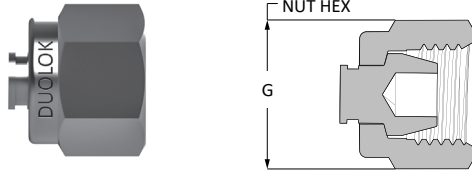

Part #		T (Tube O.D.)	G
ALLOY 405	ALLOY C-276	Fractional (in.)	
IMD2P	*	1/8	7/16
IMD4P	IHCD4P	1/4	9/16
IMD6P	IHCD6P	3/8	11/16
IMD8P	IHCD8P	1/2	7/8

\* Contact SSP for availability

## Port Connector

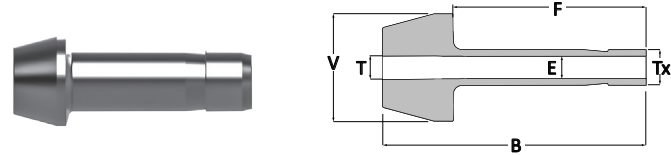

Part #		T (Tube O.D.)	B	E	F	V
ALLOY 405	ALLOY C-276	Fractional (in.)				
IMD2PC	*	1/8	0.88	0.08	0.62	0.24
IMD4PC	*	1/4	0.97	0.17	0.74	0.37
IMD4RPC2	*	1/8	0.89	0.08	0.53	0.37
IMD8PC	*	1/2	1.41	0.37	1.02	0.62

\* Contact SSP for availability

## Reducer

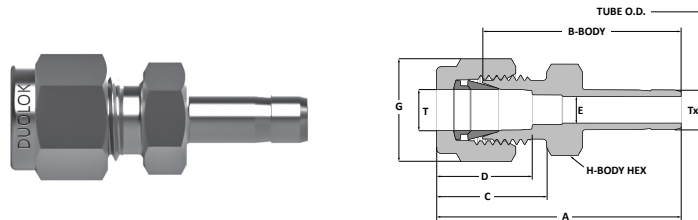

Part #		T (Tube O.D.)	Tx O.D.	A	B	C	D	E	G	H
ALLOY 405	ALLOY C-276	Fractional (in.)								
IMD2R4	IHCD2R4	1/8	1/4	1.42	1.16	0.60	0.50	0.11	7/16	7/16
IMD4R6	IHCD4R6	1/4	3/8	1.60	1.31	0.70	0.60	0.24	9/16	1/2
IMD4R8	IHCD4R8	1/4	1/2	1.82	1.53	0.70	0.60	0.33	9/16	9/16
IMD8R4	*	1/2	1/4	1.77	1.37	0.86	0.90	0.15	7/8	13/16

\* Contact SSP for availability

# Tube Fittings

## Union

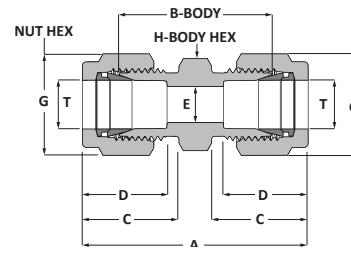
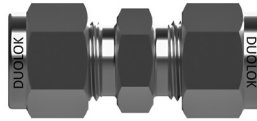

Part #		T (Tube O.D.)	A	B	C	D	E	G	H
<b>ALLOY 405</b>	<b>ALLOY C-276</b>	<b>Fractional (in.)</b>							
IMD2U	IHCD2U	1/8	1.40	0.88	0.60	0.50	0.09	7/16	7/16
IMD4U	IHCD4U	1/4	1.61	1.03	0.70	0.60	0.19	9/16	1/2
IMD6U	*	3/8	1.77	1.19	0.76	0.66	0.28	11/16	5/8
IMD8U	*	1/2	2.02	1.22	0.86	0.90	0.41	7/8	13/16
<b>Metric (mm)</b>									
IMDM6U	*	6	41.0	26.2	17.7	15.3	4.8	14	14
IMDM12U	*	12	51.2	31.0	22.0	22.8	9.5	22	22

\* Contact SSP for availability

## Reducing Union

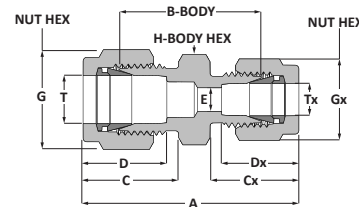
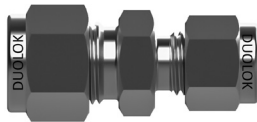

Part #		T (Tube O.D.)	Tx Tube O.D.	A	B	C	CX	D	DX	E	G	GX	H
<b>ALLOY 405</b>	<b>ALLOY C-276</b>	<b>Fractional (in.)</b>											
IMD2RU1	*	1/8	1/16	1.22	0.81	0.60	0.43	0.50	0.34	0.05	7/16	5/16	7/16
IMD4RU1	*	1/4	1/16	1.35	0.91	0.70	0.43	0.60	0.34	0.05	9/16	5/16	1/2
IMD4RU2	IHCD4RU2	1/4	1/8	1.52	0.97	0.70	0.60	0.60	0.50	0.09	9/16	7/16	1/2
IMD6RU4	*	3/8	1/4	1.70	1.12	0.76	0.70	0.66	0.60	0.19	11/16	9/16	5/8
IMD8RU4	IHCD8RU4	1/2	1/4	1.85	1.16	0.86	0.70	0.90	0.60	0.19	7/8	9/16	13/16
IMD8RU6	IHCD8RU6	1/2	3/8	1.91	1.22	0.86	0.76	0.90	0.66	0.28	7/8	11/16	13/16
IMD10RU8	*	5/8	1/2	2.05	1.25	0.86	0.86	0.96	0.90	0.41	1	7/8	15/16

\* Contact SSP for availability

# Tube Fittings

## Bulkhead Union

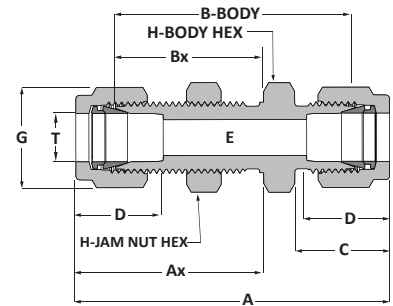
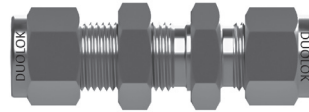

Part #		T (Tube O.D.)	A	AX	B	BX	C	D	E	G	H	Maximum Panel Thickness	Panel Hole Drill Size
<b>ALLOY 405</b>	<b>ALLOY C-276</b>	<i>Fractional (in.)</i>											
IMD4BU	*	1/4	2.27	1.32	1.69	1.03	0.70	0.60	0.19	9/16	5/8	0.40	29/64
IMD6BU	*	3/8	2.45	1.45	1.87	1.16	0.76	0.66	0.28	11/16	3/4	0.44	37/64
IMD8BU	*	1/2	2.80	1.65	2.00	1.25	0.86	0.90	0.41	7/8	15/16	0.50	49/64

\* Contact SSP for availability

## Male Elbow

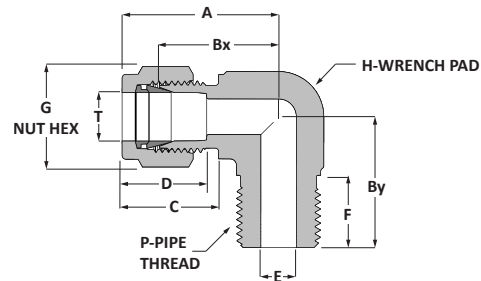
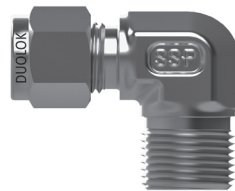

Part #		T (Tube O.D.)	P-NPT Male	A	Bx	By	C	D	E	F	G	H
<b>ALLOY 400</b>	<b>ALLOY C-276</b>	<i>Fractional (in.)</i>										
IMD4ME2	IHCD4ME2	1/4	1/8	1.06	0.77	0.74	0.70	0.60	0.17	0.38	9/16	1/2
IMD4ME4	IHCD4ME4	1/4	1/4	1.06	0.77	0.92	0.70	0.60	0.19	0.56	9/16	1/2
IMD6ME4	*	3/8	1/4	1.20	0.91	1.00	0.76	0.66	0.28	0.56	11/16	5/8
IMD6ME6	*	3/8	3/8	1.23	0.94	1.03	0.76	0.66	0.28	0.56	11/16	3/4
IMD6ME8	IHCD6ME8	3/8	1/2	1.31	1.02	1.30	0.76	0.66	0.28	0.75	11/16	7/8
IMD8ME8	IHCD8ME8	1/2	1/2	1.42	1.02	1.30	0.86	0.90	0.41	0.75	7/8	7/8

\* Contact SSP for availability

# Tube Fittings

## Union Elbow

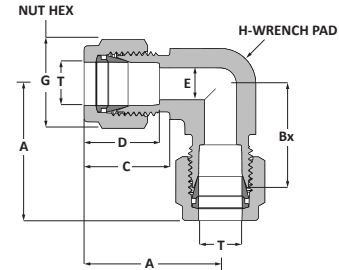

Part #		T (Tube O.D.)	A	Bx	C	D	E	G	H
ALLOY 400	ALLOY C-276	Fractional (in.)							
IMD2UE	*	1/8	0.88	0.62	0.60	0.50	0.09	7/16	3/8
IMD4UE	*	1/4	1.06	0.77	0.70	0.60	0.19	9/16	1/2
IMD6UE	*	3/8	1.20	0.91	0.76	0.66	0.28	11/16	5/8
IMD8UE	IHCD8UE	1/2	1.42	1.02	0.86	0.90	0.41	7/8	13/16

\* Contact SSP for availability

## Union Tee

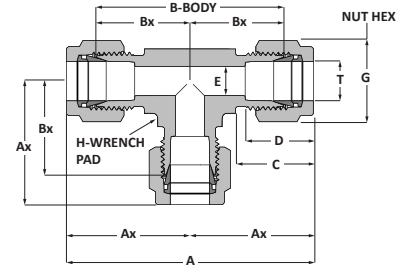

Part #		T (Tube O.D.)	A	Ax	B	Bx	C	D	E	G	H
ALLOY 400	ALLOY C-276	Fractional (in.)									
IMD2UT	IHCD2UT	1/8	1.76	0.88	1.24	0.62	0.60	0.50	0.09	7/16	3/8
IMD4UT	IHCD4UT	1/4	2.12	1.06	1.54	0.77	0.70	0.60	0.19	9/16	1/2
IMD6UT	IHCD6UT	3/8	2.40	1.20	1.82	0.91	0.76	0.66	0.28	11/16	5/8
IMD8UT	IHCD8UT	1/2	2.84	1.42	2.04	1.02	0.86	0.90	0.41	7/8	13/16
Metric (mm)											
IMDM6UT	*	6	53.9	27.0	39.1	19.6	17.7	15.3	4.8	14	1/2 in.
IMDM12UT	*	12	72.0	36.0	51.8	25.9	22.0	22.8	9.5	22	13/16 in.

\* Contact SSP for availability

# Tube Fittings

## Union Cross

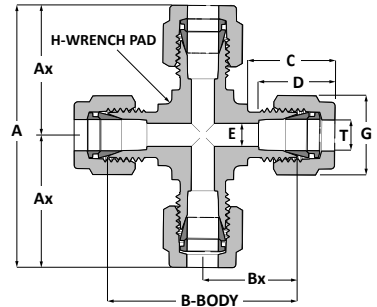
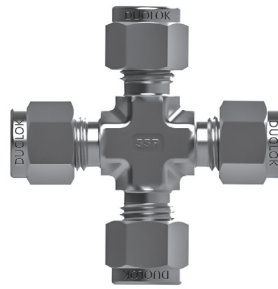

Part #		T (Tube O.D.)	A	Ax	B	Bx	C	D	E	G	H
ALLOY 400	ALLOY C-276	Fractional (in.)									
IMD4UCS	IHCD4UCS	1/4	2.12	1.06	1.54	0.77	0.70	0.60	0.19	9/16	7/16

## Female Branch Tee

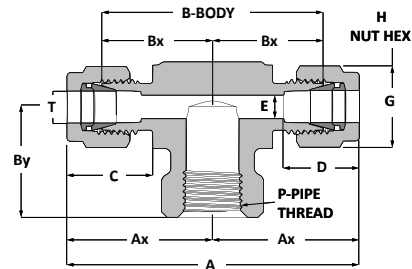

Part #		T (Tube O.D.)	P-NPT Female Pipe	A	Ax	B	Bx	By	C	D	E	G	H
ALLOY 400	ALLOY C-276	Fractional (in.)											
IMD4FBT4	*	1/4	1/4	2.34	1.17	1.76	0.88	0.88	0.70	0.60	0.19	9/16	3/4

\* Contact SSP for availability

## Female Run Tee

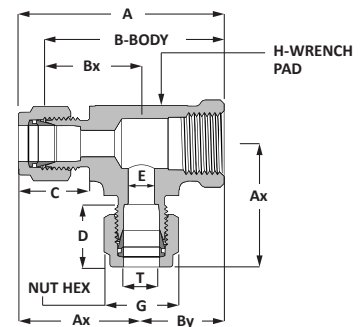
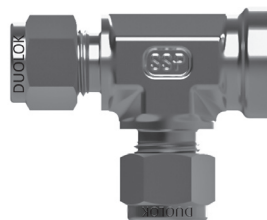

Part #		T (Tube O.D.)	P-NPT Female Pipe	A	Ax	B	Bx	By	C	D	E	G	H
ALLOY 400	ALLOY C-276	Fractional (in.)											
IMD4FRT4	*	1/4	1/4	2.05	1.17	1.76	0.88	0.88	0.70	0.60	0.19	9/16	3/4

\* Contact SSP for availability

# Tube Fittings

## Male Branch Tee

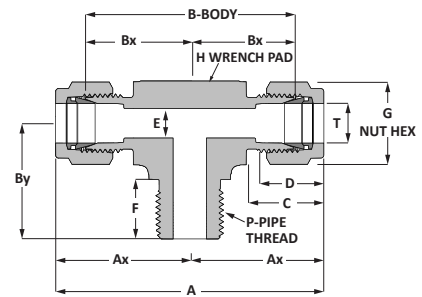

Part #		T (Tube O.D.)	P-NPT Female Pipe	A	AX	B	BX	BY	C	D	E	F	G	H
ALLOY 400	ALLOY C-276	Fractional (in.)												
IMD4MBT4	*	1/4	1/4	2.12	1.06	1.54	0.77	0.92	0.70	0.60	0.17	0.56	9/16	9/16

\* Contact SSP for availability

## Nut

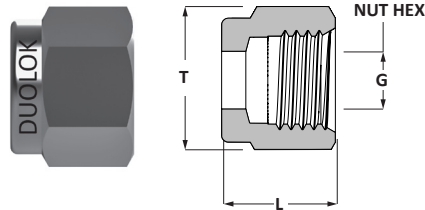

Part #		T (Tube O.D.)	G	L
ALLOY 405	ALLOY C-276	Fractional (in.)		
IMD2N	IHCD2N	1/8	7/16	0.47
IMD4N	IHCD4N	1/4	9/16	0.50
IMD6N	IHCD6N	3/8	11/16	0.56
IMD8N	IHCD8N	1/2	7/8	0.69

## Front Ferrule

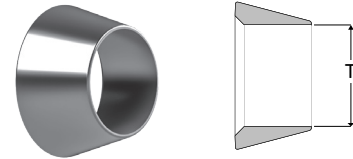

Part #		T (Tube O.D.)
ALLOY 405	ALLOY C-276	Fractional (in.)
*	*	1/16
IMD2FF	IHCD2FF	1/8
IMD4FF	IHCD4FF	1/4
IMD6FF	IHCD6FF	3/8
IMD8FF	IHCD8FF	1/2
Metric (mm)		
IMDM6FF	*	6
IMDM12FF	*	12

\* Contact SSP for availability

# Tube Fittings

## Back Ferrule

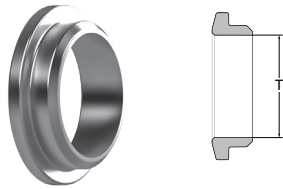

Part #		T (Tube O.D.)
ALLOY 405	ALLOY C-276	Fractional (in.)
*	*	1/16
IMD2BF	IHCD2BF	1/8
IMD4BF	IHCD4BF	1/4
IMD6BF	IHCD6BF	3/8
IMD8BF	IHCD8BF	1/2
Metric (mm)		
IMD6BF	*	6
IMD12BF	*	12

\* Contact SSP for availability

## Ferrule Set



Part #		T (Tube O.D.)
ALLOY 405	ALLOY C-276	Fractional (in.)
IMD4FS	IHCD4FS	1/4

# Pipe Fittings

## *Instrumentation Pipe Fittings*

### **TruFit® Pipe Fittings**

SSP has been manufacturing pipe fittings for more than 75 years. TruFit instrumentation pipe fittings are manufactured with high-quality NPT, threads available in sizes 1/4" - 1/2", Alloy 400/405 & Alloy C-276.

## *Product Design*

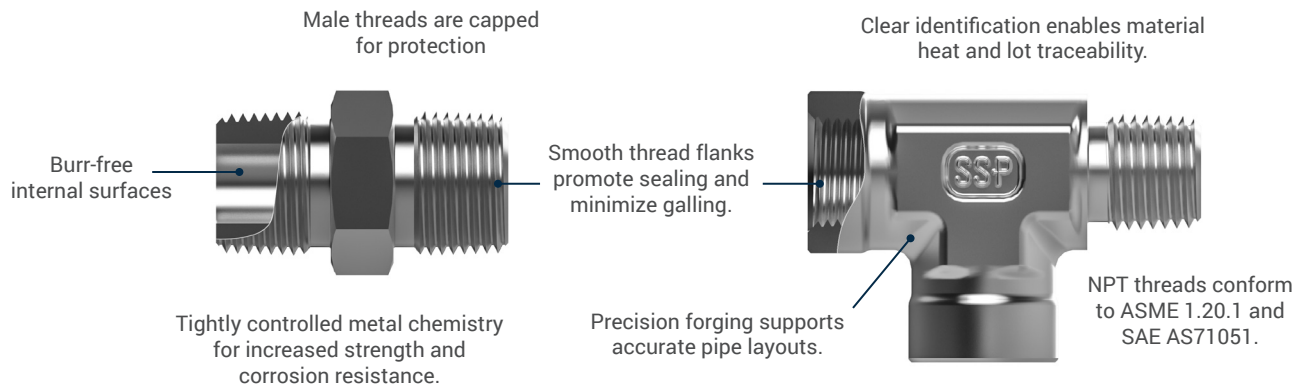



# Technical Information

TruFit Pipe Fitting Applications	
Parameter	Tapered Thread
Pressures (ASME 31.1)	High to 10,000 psi Static systems only
Temperatures	<b>Alloy 400 /405:</b> -325 to 850°F <b>Alloy C-276:</b> -325 to 1,250°F
Vibration Resistance	Fair
Sizes	1/4" to 1/2" in.
Dynamic Temperature/Pressure	Good in static systems Poor in dynamic systems
Easy of Maintenance	Limited breaks and remakes due to metal deformation of threads

## Thread Standards

Type	Designator	Standard
NPT (Tapered)	-	ASME B1.20.1

## Material Standards

Material	Bar	Forging
<b>Alloy 400/405</b>	ASTM B164	ASTM B564, ASME SB564
<b>Alloy C-276</b>	ASTM B574	ASTM B564

# Pressure - Temperature Ratings

Table 1 contains typical pressure ratings for male and female NPT and BSP tapered pipe thread ends at ambient temperature. Table 2 provides stress values. Table 3 contains derating factors for determining pressure ratings for tapered fittings at higher temperatures. For more information about pressure ratings, contact SSP customer service.

NPT/ISO Pipe Size	Size	Alloy 400				Alloy C-276			
		Male		Female		Male		Female	
		psig	bar	psig	bar	psig	bar	psig	bar
1/16"	1	9,200	630	5,600	380	15,050	1,030	15,050	1,030
1/8"	2	8,350	570	5,450	370	13,700	940	13,700	940
1/4"	4	6,700	460	5,550	380	10,950	750	10,950	750
3/8"	6	6,550	450	4,450	300	10,700	730	10,700	730
1/2"	8	6,450	440	4,100	280	10,550	720	10,550	720
3/4"	12	6,100	420	3,850	260	10,000	680	10,000	680
1"	16	4,450	300	3,700	250	7,300	500	7,300	500
Reference: MPa = 0.10 x psig				To obtain ANSI/ASME B 31.1 values, multiply ANSI/ASME B 31.3 values by .94.					

Material	Value
Alloy 400	16,700 psi (1,150 bar)
Alloy C-216	27,300 psi (1,880)

## Temperature Ratings

To determine the maximum allowable working pressure for the piping systems at elevated temperatures, multiply the applicable maximum allowable working pressure by the corresponding temperature stress factor from Table 3. System temperatures may be limited by the thread sealant or when applicable, the gasket or O-ring materials.

Temperature		Alloy 400	Alloy C-276
°F	°C		
100	38	1.00	1.00
200	93	0.88	1.00
300	149	0.82	1.00
400	204	0.79	1.00
500	260	0.79	0.99
600	316	0.79	0.92
700	371	0.79	0.88
800	427	0.76	0.85
900	482	0.43	0.83
1000	538	-	0.82
1200	649	-	0.36

<sup>1</sup>Temperature limitation of Zinc coating (375°F) used on carbon steel fittings.

# How to Order

## Ordering Instructions

- ① Select the Instrumentation Material Designator from the Chart A. Example: **IM**T4PT
- ② Add the SSP Brand Designator ("T" for TruFit). Example: IM**T**4PT
- ③ Add the Thread Size from Chart C. Example: IMT**4**PT
- ④ Add the Type of Pipe Fitting from Chart D. Example: IMT4**PT**
- ⑤ Add options if required

Basic Part Number      Options

**A** **B** **C** **D** - **E**

IM   T   4   PT

<p><b>A MATERIAL</b></p> <p>IHC Hastelloy C IM Monel</p> <p><b>B SSP BRAND DESIGNATOR</b></p> <p>T TruFit</p> <p><b>C SIZE</b></p> <p>4 1/4" 6 3/8" 8 1/2"</p>	<p><b>D PIPE FITTING TYPE</b></p> <p>HLN Hex Long Nipple HN Hex Nipple PP Pipe Plug PT Pipe Tee</p>	<p><b>E OPTIONS</b></p> <p>-XP98 PER ASTM G93 Level C -XP97 No Lube</p>
--	---	---

## Pipe Fittings

### Hex Long Nipple

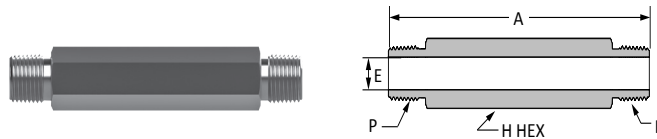

Part #		P Male NPT	A	E Minimum Opening	H
<b>Alloy 405</b>	<b>Alloy C-276</b>	<i>Fractional (in.)</i>			
IMT8HLN3.0	*	1/2	3.00	0.47	7/8
IMT8HLN4.0	*	1/2	4.00	0.47	7/8

\* Contact SSP for availability

# Pipe Fittings

## Hex Nipple

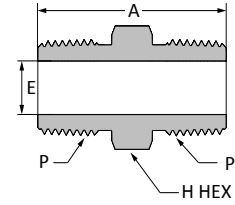
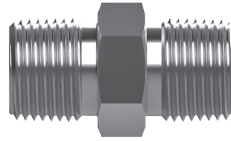

Part #		P Male NPT	A	E Minimum Opening	H
<b>Alloy 405</b>	<b>Alloy C-276</b>	<i>Fractional (in.)</i>			
IMT4HN	IHCT4HN	1/4	1.45	0.28	5/8
IMT8HN	IHCT8HN	1/2	1.89	0.53	7/8

## Pipe Plug

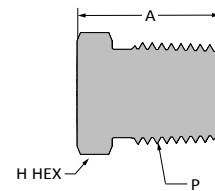
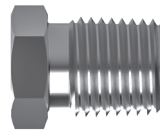

Part #		P Male NPT	A	H
<b>Alloy 405</b>	<b>Alloy C-276</b>	<i>Fractional (in.)</i>		
IMT4PP	IHCT4PP	1/4	0.74	9/16
IMT6PP	IHCT6PP	3/8	0.78	11/16
IMT8PP	IHCT8PP	1/2	0.97	7/8

## Tee

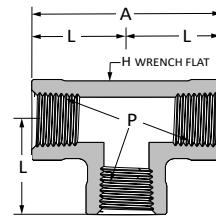

Part #		P Male NPT	A	H	L
<b>Alloy 405</b>	<b>Alloy C-276</b>	<i>Fractional (in.)</i>			
IMT4PT	*	1/4	1.76	3/4	0.88

\* Contact SSP for availability

# Needle Valves

## 100 & 600 Series Integral Bonnet Needle Valves

SSP Needle Valves are designed for positive shut-off and regulation control of media in instrumentation and process systems. With a variety of end connections, temperature ranges, and pressures, integral bonnet needle valves are used in a wide range of instrumentation, control, utility and mechanical systems.



General Specifications	
Max. Working Pressure	5000 psig (344 bar)
Temperature Range	-40 to 600°F (-40 to 315°C)
Orifice Size	0.063 to 0.343 (1.6 to 8.71)
Body Materials	Alloy 400
Packing Materials	PTFE
Flow Patterns	Straight
Stem Types	Alloy 400 Vee Tip
End Connection Types	Fractional Tube Fittings, and NPT
End Connection Sizes	1/8 to 1/2 in.

## Product Design

- 1 LIVE LOADED CHEVRON PACKING**
  - Fully supported packing prevents extrusion
  - Self-adjusting reduces maintenance and packing adjustments
  - Easy inline adjustment
- 2 CHROME PLATED STEM**
  - Greater corrosion and gall resistance for increased durability
  - Precision threads for leak-tight shut off

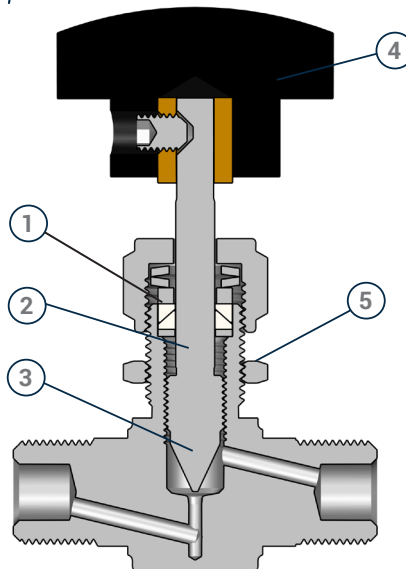

- 3 STEM TIP**
  - Vee-tip
  - PCTFE
- 4 DURABLE HANDLE**
  - Nylon
  - Brass insert
  - Color coded
  - Stainless steel knurled and T-bar handles available
- 5 PANEL MOUNTING**

# Technical Information

## Materials of Construction

ID	Component	Material/Standard
		Alloy 400
1*	Body	Alloy 400 / B564
2	Panel Nut	316 SS / A479
3*	Stem	Alloy 400 / R-405 / B164
4*	Packing Support	Alloy 400 / R-405 / B164
5*	Lower Packing	PTFE
6*	Upper Packing	PTFE
7	Packing Pusher	Alloy 400 / R-405 / B164
8	Packing Springs	301 SS
9	Packing Nut	Alloy 400 / R-405 / B164
10	Set Screw	Stainless Steel
11	Handle	Nylon

\*Wetted Components

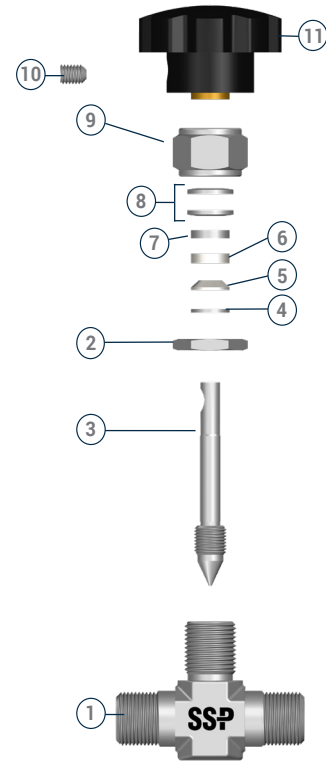

## Pressure - Temperature

Data reflects temperature ratings from both process and environmental sources. Pressure ratings are based on valves with graphite pac king.

- 600°F (316°C) max. with PEEK packing
- 450°F (232°C) max. with PTFE packing

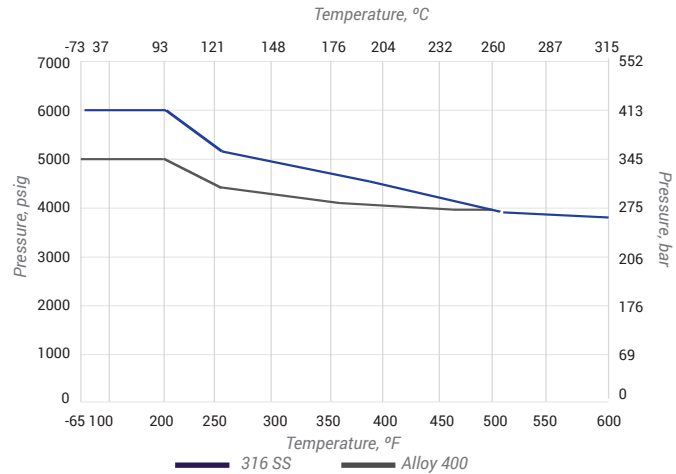

## Flow Data

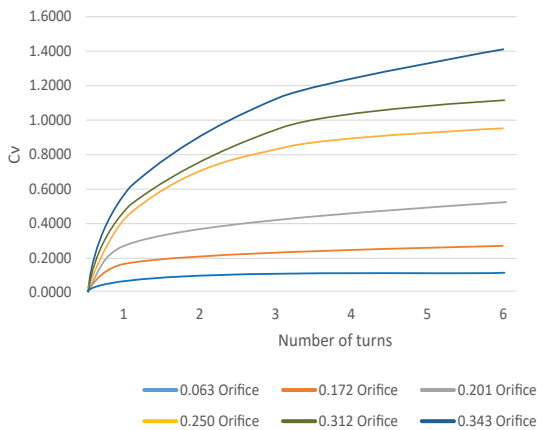

# How to Order

## Ordering Instructions

- ① Add the Body, orifice, end connection Designator from the chart A. Example: **118**-K-M-TBH
- ② Add the stem type from chart B. Example: 118-**K**-M-TBH
- ③ Add the material designator from Chart C. Example: 118-K-**M**-TBH
- ④ Add options from the Chart D. Example: 118-K-M-**TBH**

Basic Part Number

Options

A  
 B  
 C  
 -  
 D  
 118   -K   -M   -TBH

A **BODY/ORIFICE/END CONNECTIONS**  
 See the Basic Part Number and Dimensions table on page 32

B **STEM**  
 Blank Monel  
 -K PCTFE

C **MATERIAL**  
 M Monel

D **OPTIONS<sup>1</sup>**

**Packing**

Blank PTFE  
 -PK PEEK

**Handles**

Blank Black (Standard)  
 -RD Red  
 -GR Green  
 -TBH -316 SS Tee Bar

**Special Cleaning**

-XP98 PER ASTM G93 Level C

<sup>1</sup>Option designators are arranged in alphabetical order.

# Needle Valves

## 100/600 Series Valves

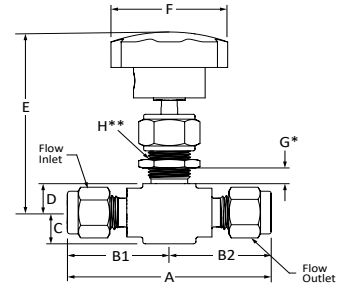

End Connection		Alloy 400 Part Number	Dimensions in. (mm) <sup>3</sup>									
Inlet/Outlet	Size		Orifice	A	B1	B2	C	D	E	F	G	H
Fractional Tube Fitting	1/8	104-M	0.063 (1.6)	2.34 (59.3)	1.17 (29.7)	1.17 (29.7)	0.40 (10.16)	0.38 (9.7)	2.55 (64.8)	1.38 (35.1)	0.38 (9.7)	17/32 (13.5)
		106-M	0.063 (1.6)	2.40 (61.0)	1.20 (30.5)	1.20 (30.5)	0.40 (10.16)	0.38 (9.7)	2.55 (64.8)	1.38 (35.1)	0.38 (9.7)	17/32 (13.5)
	1/4	118-M	0.172 (4.4)	2.40 (61.0)	1.20 (30.5)	1.20 (30.5)	0.40 (10.16)	0.38 (9.7)	2.55 (64.8)	1.38 (35.1)	0.38 (9.7)	17/32 (13.5)
		124-M	0.172 (4.4)	2.40 (61.0)	1.20 (30.5)	1.20 (30.5)	0.40 (10.16)	0.38 (9.7)	2.55 (64.8)	1.38 (35.1)	0.38 (9.7)	17/32 (13.5)
	3/8	626-M	0.250 (6.4)	2.58 (65.5)	1.29 (32.8)	1.29 (32.8)	0.44 (11.2)	0.44 (11.2)	3.15 (80.0)	1.75 (44.5)	0.38 (9.7)	25/32 (19.8)
		651-M	0.250 (6.4)	2.80 (71.1)	1.40 (35.6)	1.40 (35.6)	0.44 (11.2)	0.44 (11.2)	3.15 (80.0)	1.75 (44.5)	0.38 (9.7)	25/32 (19.8)
	1/2	654-M	0.312 (7.9)	2.80 (71.1)	1.402 (35.6)	1.40 (35.6)	0.44 (11.2)	0.44 (11.2)	3.15 (80.0)	1.75 (44.5)	0.38 (9.7)	25/32 (19.8)
		657-M	0.343 (8.7)	2.80 (71.1)	1.402 (35.6)	1.40 (35.6)	0.44 (11.2)	0.44 (11.2)	3.15 (80.0)	1.75 (44.5)	0.38 (9.7)	25/32 (19.8)
Male NPT	1/8	100-M	0.063 (1.6)	1.82 (46.2)	0.91 (23.1)	0.91 (23.1)	0.40 (10.2)	0.38 (9.7)	2.55 (64.8)	1.38 (35.1)	0.38 (9.7)	17/32 (13.5)
		112-M	0.172 (4.4)	1.82 (46.2)	0.91 (23.1)	0.91 (23.1)	0.40 (10.2)	0.38 (9.7)	2.55 (64.8)	1.38 (35.1)	0.38 (9.7)	17/32 (13.5)
	1/4	102-M	0.063 (1.6)	1.82 (46.2)	0.91 (23.1)	0.91 (23.01)	0.40 (10.2)	0.38 (9.7)	2.55 (64.8)	1.38 (35.1)	0.38 (9.7)	17/32 (13.5)
		116-M	0.172 (4.4)	1.82 (46.2)	0.91 (23.1)	0.91 (23.1)	0.40 (10.2)	0.38 (9.7)	2.55 (64.8)	1.38 (35.1)	0.38 (9.7)	17/32 (13.5)
Male NPT to Fractional Tube Fitting	1/8	105-M	0.063 (1.6)	2.08 (52.8)	0.91 (23.1)	1.17 (29.7)	0.40 (10.2)	0.38 (9.7)	2.55 (64.8)	1.38 (35.1)	0.38 (9.7)	17/32 (13.5)
	1/4	122-M	0.172 (4.4)	2.11 (53.6)	0.91 (23.1)	1.20 (30.5)	0.40 (10.2)	0.38 (9.7)	2.55 (64.8)	1.38 (35.1)	0.38 (9.7)	17/32 (13.5)
Male NPT to Female NPT	1/4	603-M	0.063 (1.6)	2.00 (50.8)	1.00 (25.4)	1.00 (25.4)	0.44 (11.2)	0.44 (11.2)	2.61 (66.3)	1.38 (35.1)	0.38 (9.7)	17/32 (13.5)
		603-2-M	0.172 (4.4)	2.00 (50.8)	1.00 (25.4)	1.00 (25.4)	0.44 (11.2)	0.44 (11.2)	2.61 (66.3)	1.38 (35.1)	0.38 (9.7)	17/32 (13.5)



# LN Series

## LN Series

### Locked bonnet Needle Valves

#### A Better Severe Service Needle Valve

LN Series and HLN Series Locked Bonnet Needle Valves offer important advantages over union bonnet and other severe service needle valve designs. LN Series valves are designed for severe service applications having pressures up to 6,000 psig (413 bar) LN series can be used in applications with high vibration, corrosive media, and frequent cycling, in temperatures from -100 to 1200°F (-73 to 648°C).

#### Safer Bonnet Design

In the locked bonnet design, the bonnet is screwed into the valve body to create a metal to metal seal below the bonnet threads. The bonnet is locked in place with a lock ring, which is secured with a separate screw. This prevents accidental disassembly during packing adjustment, loosening due to vibration, or unscrewing of the bonnet by continuing to rotate the stem after the valve is fully open. The back-seating lower stem allows inline packing adjustments to be made more safely.

#### Better Non-Rotating Stem Tip Design

Unlike non-rotating ball stem tips, LN Series valves are designed with a non-rotating lower stem that prevents damage to the seat and stem tip and reduces wear to the packing. The threaded upper stem and stem pivot are located above the packing preventing system media from attacking the threads and washing away thread lubricants and to prevent contamination and corrosion from seizing up the non-rotating tip.

#### Leak-Tight Reliability and Low Maintenance

LN Series valves are designed with live-loaded packing that provides a dynamic leak-tight stem seal, which compensates for changes in pressure, temperature, and packing wear. Along with the non-rotating stem, live-loaded packing can reduce emissions, packing adjustments and maintenance.

LN Series locked bonnet design

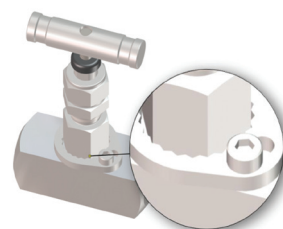

Stem pivot is protected above the packing.



Live-Loaded Chevron Packing below the threads and stem pivot.

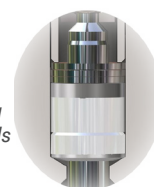

Lower stem does not rotate within the packing preventing seat and stem tip damage and reducing packing wear.

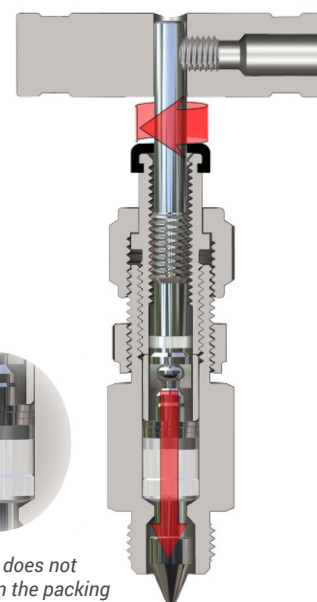

#### Applications

LN Series valves provide reliable shut off, regulating and metering control in oil & gas exploration and refining, instrumentation, test stands, steam systems, control systems and many other applications where hazardous media, higher temperatures, pressures, and vibration are common.

## Product Design

- 1 LIVE LOADED CHEVRON PACKING**

  - Reduces need for packing adjustments
  - Compensates for wear
  - Compensates for pressure and temperature changes
  - Packing support prevents extrusion of the packing
  - Flexible graphite packing is available for high-temperature applications
- 2 BACK SEATING STEM**

  - Easy access to packing bolt – nothing to disassemble
  - Allows in line packing adjustment in pressurized system
  - Isolates the packing when the valve is in the fully open position
- 3 HARDENED NON-WETTED STEM THREADS**

  - Hardened 17-4 PH stainless steel
  - High cycle life
  - Retain lubricants for easy operation and longer cycle life
- 4 DUST CAP**

  - Prevents contamination of the stem threads from the environment
  - Colored vent and isolation caps for safety
- 5 BONNET LOCK PLATE**

  - Locks bonnet in place to prevent accidental disassembly
  - Positive lock is superior to pin-type retainers

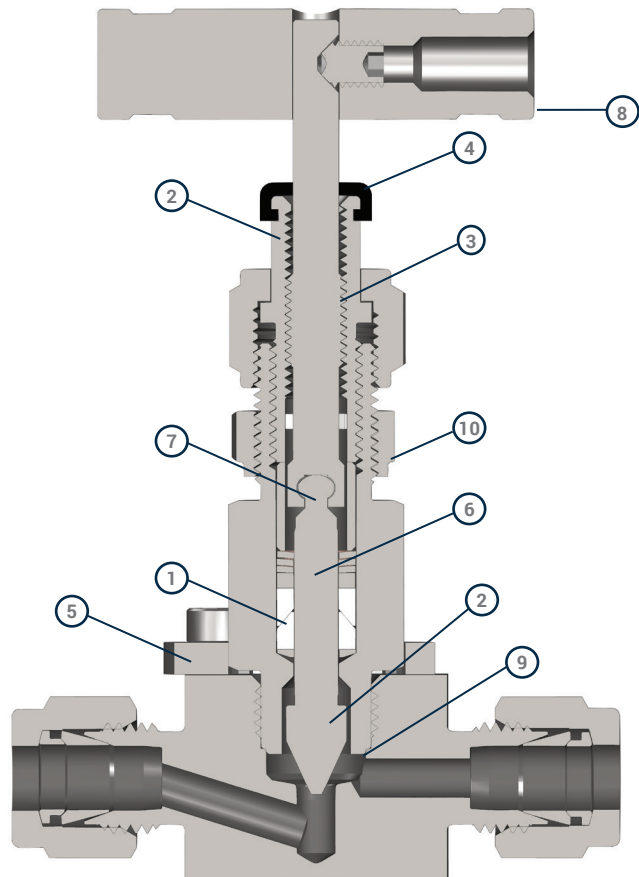

*Meets ASME B31.1 and B31.3 design pressure calculations*

- 6 NON ROTATING LOWER STEM**

  - Prevents damage to the seat and stem tip for repetitive leak-tight sealing even in severe environments
  - Reduces packing maintenance because the stem does not rotate within the packing
  - Vee-type, soft-seal shutoff, regulating, and metering stem tips are available
- 7 NON-WETTED, STEM PIVOT INTERLOCK**

  - Prevents system media from infiltrating and seizing up the stem joint
- 8 DURABLE STAINLESS STEEL HANDLE**

  - Large ergonomic handle for easier actuation
- 9 METAL TO METAL BONNET SEAL**

  - Higher temperatures and chemical compatibility

# Materials of Construction

ID	Component	Body Material	
		Alloy 400	Alloy C-276
1	Handle Screw	316 SS/A276	
2	T-Bar Handle	303/A582	
3	Cap	NBR/ D2000	
4	Packing Nut	316 SS/A276	
5	Packing Bolt	316 SS/A276	
6	Stem Guide	PEEK	
7	Upper Stem	17-4 PH/ A564	
8	Packing Spacer	316 SS/A276	
9	Packing Springs	301/A666	
10	Packing Washer	316 SS/A276	
11*	Upper Packing	PTFE/D1710, Flexible Graphite, PEEK <sup>1</sup>	
12*	Lower Packing	PTFE/D1710, Flexible Graphite, PEEK <sup>1</sup>	
13*	Packing Support	Alloy 405/B164	Alloy C-276/B574
14*	Vee Stem	Chrome Plated Alloy 405/B164	Chrome Plated Alloy C-276/B574
15*	Metering Stem		
16*	Regulating Stem		
17*	Soft Seal Stem	Alloy 405/B164, PCTFE/AMS 3650	Alloy C-276/B574, PCTFE/AMS 3650
18	Socket Screw	316 SS/A276	
19	Panel Nut	316 SS/A276	
20	Bonnet Lock	316 SS/A276	
21*	Bonnet	Alloy 405/ B164	Alloy C-276/B574
22*	Body	Alloy 400/B164	Alloy C-276/B574
	Packing Lubricant	Fluorocarbon-based lubricant	
	Thread Lubricant	Fluorocarbon-based lubricant with Tungsten Disulfide	

\*Wetted components  
<sup>1</sup>PEEK Packing is available for LN6 Series valves only.

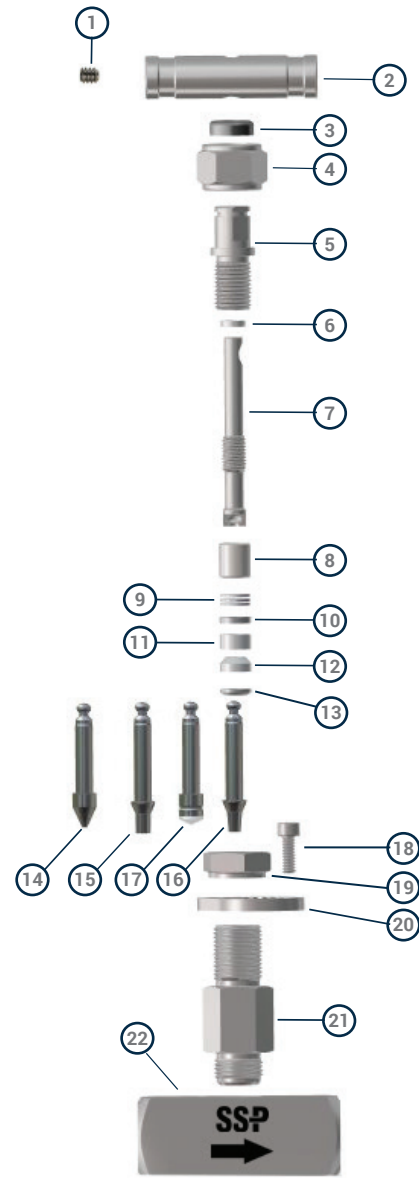

## Pressure -Temperature

Data reflects temperature ratings from both process and environmental sources. Pressure ratings are based on valves with graphite packing.

- 600°F (316°C) max. with PEEK\* packing
- 450°F (232°C) max. with PTFE packing
- 200°F (93°C) max. with PCTFE stem tip

\* Available for LN6 valves only.

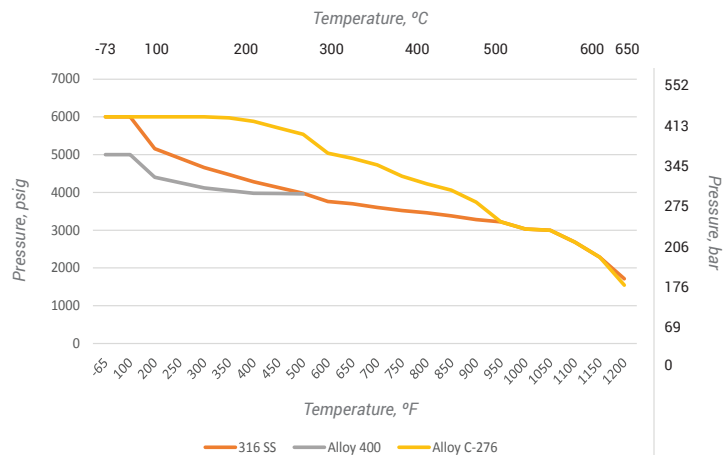

# Flow Data

Valves with vee-tip and soft seal (PCTFE) tip stems are designed to be operated in the fully open or closed position. See the Part Number and Dimensions tables for flow data.

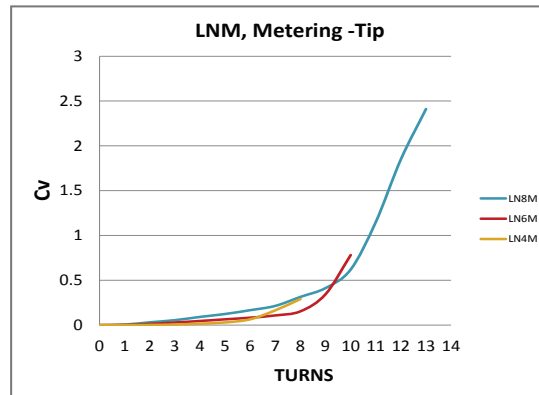
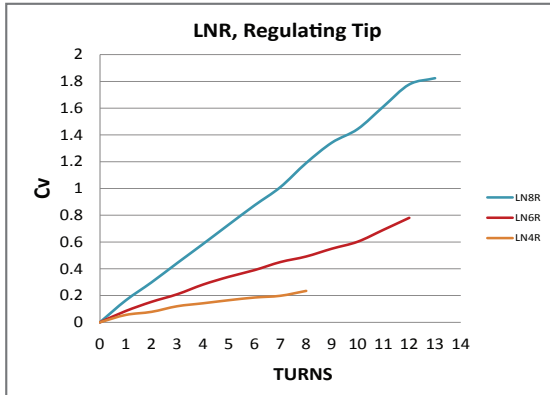

# How to Order

- 1 Locate the Basic Part Number & Dimensions table on page 37.
- 2 Locate the Basic Part Number with the required end connection type, end connection size and orifice size. Example: LN4-D4-M
- 3 Add the Stem Type Designator after the Valve Size Designator (See chart C). Example LN4V-D4-M
- 4 If optional flexible graphite or PEEK packing is required, add the Stem Packing Designator. (See chart C) Example: LN4VP-D4-M
- 5 Add the Body Material Designator (See chart F). Example: LN4VP-D4-M
- 6 Add designators for other options in alphabetical order. Example: LN4VP-D4-M-XP98

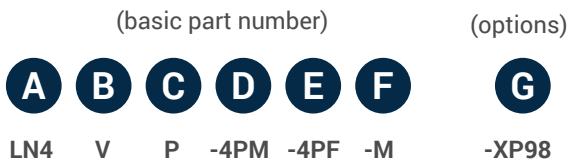

**A** SERIES / SIZE  
 LN4 0.156 Orifice  
 LN6 0.250 Orifice  
 LN8 0.437 Orifice

**B** STEM TYPE  
 V Vee  
 M Metering  
 K Soft Seal, PCTFE  
 R Regulating

**C** PACKING MATERIAL  
 Blank PTFE  
 G Flexible Graphite  
 P PEEK<sup>2</sup>

**D** + **E** INLET<sup>1</sup> + OUTLET<sup>1</sup>

Type:	Fractional Sizes:
D Duolok® Tube Fitting	2 1/8 in.
PF Female NPT	4 1/4 in.
PM Male NPT	6 3/8 in.
PSW Pipe Socket Weld	8 1/2 in.
	12 3/4 in.

**F** BODY MATERIAL  
 -M Alloy 400  
 -HC Alloy C-276

**G** OPTIONS  
**SPECIAL CLEANING**  
 -XP98 Oxygen compatible lubricant, per ASTM G93, Level C and CGA G-4.1

# LN Series

## Straight Pattern

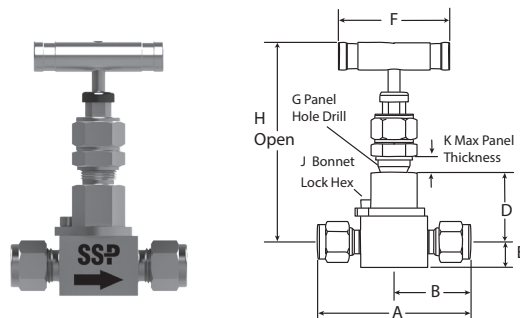

End Connection			Alloy 400 Part Number	Alloy C-276 Part Number	Cv	Orifice in. (mm)	Dimensions, in. (mm)								
Type	Inlet Size	Outlet Size					A	B	D	E	F	G	H	J	K
Fractional Tube Fitting <sup>1</sup>	1/4 in.	1/4 in.	LN4-D4-M	LN4-D4-HC	0.34	0.156 (4.0)	2.40 (61.0)	1.20 (30.5)	1.09 (27.7)	0.41 (10.4)	1.75 (44.5)	9/16 (14.3)	3.22 (81.8)	7/64 (2.8)	0.24 (6.1)
	3/8 in.	3/8 in.	LN6-D6-M	LN6-D6-HC	0.84	0.250 (6.35)	2.83 (71.9)	1.42 (36.1)	1.34 (34.0)	0.50 (12.7)	2.50 (63.5)	11/16 (17.5)	3.93 (99.8)	5/32 (3.9)	0.28 (7.1)
	1/2 in.	1/2 in.	LN6-D8-M	LN6-D8-HC	0.85	0.250 (6.35)	3.04 (77.2)	1.52 (38.6)	1.34 (34.0)	0.50 (12.7)	2.50 (63.5)	11/16 (17.5)	3.93 (99.8)	5/32 (3.9)	0.28 (7.1)
	1/2 in.	1/2 in.	LN8-D8-M	LN8-D8-HC	1.90	0.437 (11.1)	3.92 (99.6)	1.96 (49.8)	1.82 (46.2)	0.63 (15.9)	3.50 (89.0)	1 1/32 (20.2)	5.03 (127.8)	3/16 (4.8)	0.32 (8.1)
Female NPT	1/8 in.	1/8 in.	LN4-2PF-M	LN4-2PF-HC	0.34	0.156 (4.0)	2.00 (50.8)	1.00 (25.4)	1.09 (27.7)	0.41 (10.4)	1.75 (44.5)	9/16 (14.3)	3.22 (81.8)	7/64 (2.8)	0.24 (6.1)
	1/4 in.	1/4 in.	LN4-4PF-M	LN4-4PF-HC	0.34	0.156 (4.0)	2.06 (52.3)	1.03 (26.2)	1.09 (27.7)	0.41 (10.4)	1.75 (44.5)	9/16 (14.3)	3.22 (81.8)	7/64 (2.8)	0.24 (6.1)
	1/4 in.	1/4 in.	LN6-4PF-M	LN6-4PF-HC	0.85	0.250 (6.35)	2.25 (57.2)	1.13 (28.7)	1.34 (34.0)	0.50 (12.7)	2.50 (63.5)	11/16 (17.5)	3.93 (99.8)	5/32 (3.9)	0.28 (7.1)
	3/8 in.	3/8 in.	LN6-6PF-M	LN6-6PF-HC	0.85	0.250 (6.35)	2.25 (57.2)	1.13 (28.7)	1.34 (34.0)	0.50 (12.7)	2.50 (63.5)	11/16 (17.5)	3.93 (99.8)	5/32 (3.9)	0.28 (7.1)
	1/2 in.	1/2 in.	LN8-8PF-M	LN8-8PF-HC	2.18	0.437 (11.1)	3.12 (79.3)	1.56 (39.6)	1.82 (46.2)	0.63 (15.9)	3.50 (89.0)	1 1/32 (20.2)	5.03 (127.8)	3/16 (4.8)	0.32 (8.1)
	3/4 in.	3/4 in.	LN8-12PF-M	LN8-12PF-HC	2.18	0.437 (11.1)	3.25 (82.6)	1.63 (41.4)	1.91 (48.5)	0.78 (19.8)	3.50 (89.0)	1 1/32 (20.2)	5.34 (135.6)	3/16 (4.8)	0.32 (8.1)
Male NPT	1/4 in.	1/4 in.	LN6-4PM-M	LN6-4PM-HC	0.85	0.250 (6.35)	2.50 (63.5)	1.25 (31.8)	1.34 (34)	0.50 (12.7)	2.50 (63.5)	11/16 (17.5)	3.93 (99.8)	5/32 (3.9)	0.28 (7.1)
Pipe Socket Weld	1/4 in.	1/4 in.	LN4-4PSW-M	LN4-4PSW-HC	0.34	0.156 (4.0)	1.75 (44.5)	0.88 (22.4)	1.09 (27.7)	0.41 (10.4)	1.75 (44.5)	9/16 (14.3)	3.22 (81.8)	7/64 (2.8)	0.24 (6.1)
	3/8 in.	3/8 in.	LN6-6PSW-M	LN6-6PSW-HC	0.85	0.250 (6.35)	2.25 (57.2)	1.13 (28.7)	1.34 (34.0)	0.50 (12.7)	2.50 (63.5)	11/16 (17.5)	3.93 (99.8)	5/32 (3.9)	0.28 (7.1)
	1/2 in.	1/2 in.	LN8-8PSW-M	LN8-8PSW-HC	2.00	0.437 (11.1)	3.00 (76.2)	1.50 (38.1)	1.82 (46.2)	0.63 (15.9)	3.50 (89.0)	1 1/32 (20.2)	5.03 (127.8)	3/16 (4.8)	0.32 (8.1)

# Check Valves

## CH Series

### High-Pressure Check Valves

CH Series check valves are designed for high pressure, high cycle applications up to 6000 psig (413 bar). They are available with a variety of O-ring materials. Standard cracking pressures range from 1 to 25 psig (0.07 to 1.7 bar).



## Product Design

- |   |  |
|---|--|
| <p>① <b>O-ring</b></p> <ul style="list-style-type: none"> <li>• Wide variety of o-ring materials</li> <li>• Easy maintenance</li> </ul>   | <p>③ <b>Metal Poppet</b></p> <ul style="list-style-type: none"> <li>• Vee shape maximizes sealing area</li> <li>• Reduces wear</li> </ul>  |
| <p>② <b>O-ring Retainer</b></p> <ul style="list-style-type: none"> <li>• Holds the O-rings in place</li> <li>• Fully supports the O-ring to prevent extrusion</li> <li>• Reduces wear and potential for damage</li> </ul> | <p>④ <b>Connector Gasket</b></p> <ul style="list-style-type: none"> <li>• Metal to metal seal to the environment</li> </ul> <p>⑤ <b>Poppet Stop</b></p> <ul style="list-style-type: none"> <li>• Prevents spring over-compression</li> </ul> |

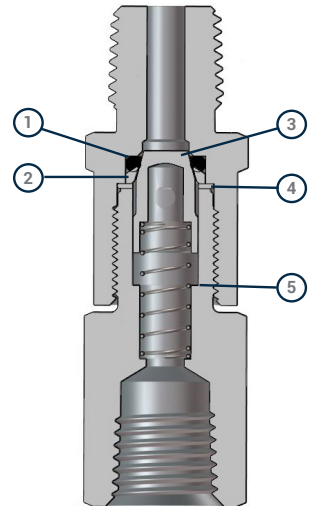

# Technical Information

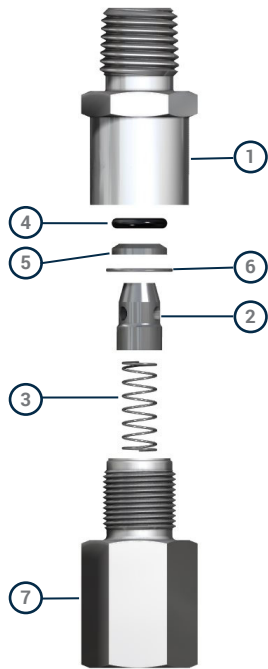

## Materials of Construction

ID	Component	Material/Specification	
		Alloy 400 / R-405	Alloy C-276
1*	Inlet Body	Alloy 400 or R-405 / B164	Alloy C-276 / B574
2*	Poppet	Alloy 400 or R-405 / B164	Alloy C-276 / B574
3*	Spring	Alloy X-750 / AMS 5699	Alloy X-750 / AMS 5699
4*	O-ring	Fluorocarbon FKM	Perfluoroelastomer FFKM
5*	O-ring Retainer	Alloy 400 or R-405 / B164	Alloy C-276 / B574
6*	Connector Gasket	Alloy 400 or R-405 / B164	Alloy C-276 / B574
7*	Outlet Body	Alloy 400 or R-405 / B164	Alloy C-276 / B574
	Wetted Lubricant	PTFE - Based	

\*Wetted components

## Temperature-Pressure Tables

Material	Alloy 400/R-405	Alloy C-276
End Connections	D2, D4, D6	D2, D4, D6
Temperature, °F (°C)	Working Pressure, psig (bar)	
-10 (-23) to 0 (-18)	6000 (413)	-
100 (37)		6000 (413)
200 (93)	5200 (358)	5200 (358)
300 (148)	4700 (324)	4700 (324)
400 (204)	4300 (296)	4300 (296)

Note: Ratings based on fluorocarbon FKM O-rings in Alloy 400/R-405 valves and perfluoroelastomer FFKM O-rings in Alloy C-276 valves.

O-Ring Material Options		
Material		Temperature Rating °F (°C)
Fluorocarbon FKM	V	-23 to 400 (-17 to 204)
Nitrile	BN	-30 to 250 (-34 to 121)
Ethylene Propylene	EP	-50 to 250 (-45 to 121)
Neoprene	NE	-30 to 250 (-34 to 121)
Perfluoroelastomer FFKM	FFKM3	0 to 400 (-18 to 204)
Kalrez®/FFKM	KZ	0 to 400 (-18 to 204)

## Cracking & Reseal Pressures

Nominal Cracking Pressure psig (bar)	Cracking Pressure Range psig (bar)	Reseal Pressure psig (bar)
1 (0.07)	Up to 4 (0.28)	Up to 5 (0.35) back pressure
10 (0.69)	7 to 15 (0.49 to 1.1)	3 (0.21) or more inlet pressure
25 (1.8)	20 to 30 (1.4 to 2.1)	17 (1.2) or more inlet pressure

# How to Order

## Ordering Instructions

- ① Locate the basic part number for the valve with the required end connection type and size.  
*Example: CH4-D4*
- ② Add designator for the required cracking pressure. *Example: CH4-D4-10.*
- ③ Add the body material designator to the part number. *Example: CH4-D4-10-HC*
- ④ Select optional O-ring material. *Example: CH4-D4-10-HC-EP*
- ⑤ Add additional options and accessories in alphabetical order. *Example: CH4-D4-10-HC-EP-XP98*

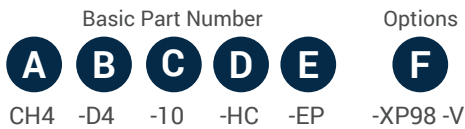

<p><b>A</b> SERIES / SIZE</p> <p>CH4 CH8</p>	<p><b>B</b> INLET TYPE + SIZE</p> <p>D Duolok® Tube Fitting</p> <p><i>Fractional Sizes:</i> 2 1/8 in. 4 1/4 in. 6 3/8 in.</p>	<p><b>E</b> O-RING</p> <p>-V Fluorocarbon FKM -BN Nitrile -NE Ethylene Propylene -FFKM3 Perfluoroelastomer FKM -KZ Kalrez® /FFKM</p>
<p><b>C</b> CRACKING PRESSURE</p> <p>1 1 PSI 10 10 PSI 25 25PSI</p>	<p><b>D</b> BODY MATERIAL</p> <p>-M Alloy 400/R-405 -HC Alloy C-276</p>	<p><b>F</b> OPTIONS</p> <p><b>SPECIAL CLEANING</b></p> <p>-XP98 ASTM G93, Level C and CGA G-4.1</p>

## CH Series

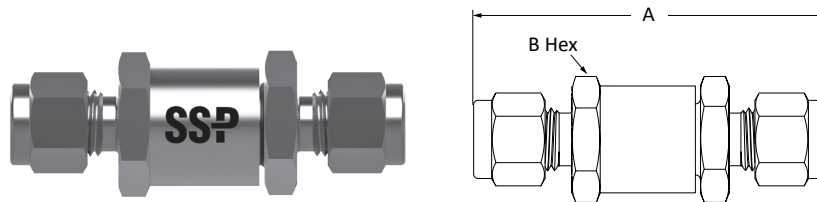

End Connections		Alloy 400 Part Number	Alloy C-276 Part Number	Cv	Dimensions	
Type	Size				A in. (mm)	B in.
Fractional Tube Fitting	1/8	CH4-D2-M	CH4-D2-HC	0.60	2.27 (57.7)	11/16
	1/4	CH4-D4-M	CH4-D4-HC	0.60	2.44 (62.0)	11/16
	3/8	CH8-D6-M	CH8-D6-HC	2.15	2.75 (69.9)	1



# 4000 Series

## Ball Poppet Check Valves

4000 Series ball poppet check valves control back flow and maintain upstream pressure in applications have working pressures up to 6000 psig (413 bar) and temperatures from -15 to 350° F (-18 to 176°C).

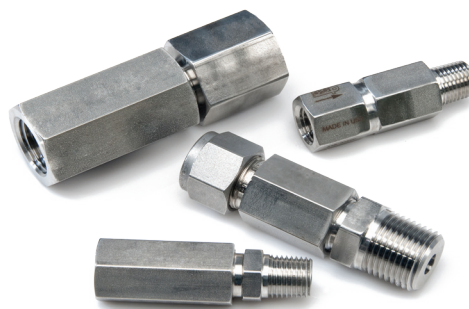

## Product Design

- ① **Fully Contained O-rings**
  - Prevents O-ring extrusion and blow-out
  - Reduces seal wear
- ② **Caged Ball**
  - Seals well in high and low pressure
  - Reliable cracking and resealing
- ③ **Stem Positive Stop**
  - Prevents spring over-compression
- ④ **Variety of End Connections**

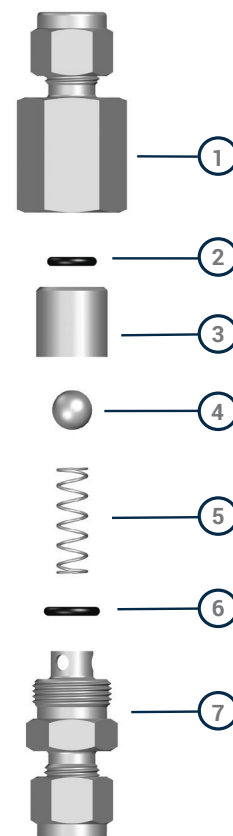
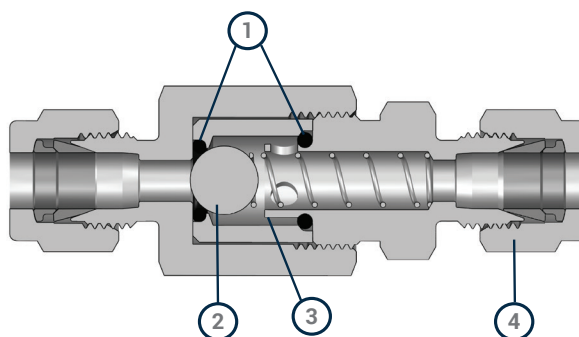

## Materials of Construction

ID	Component	Material / Specifications	
		Alloy 400 / R-405	ALLOY C-276
1*	Body	Alloy 400 or R-405 / B164	Alloy C-276 / B574
2*	O-ring	Fluorocarbon FKM	Perfluoroelastomer FFKM
3*	Ball Cage	Alloy 400 or R-405 / B164	Alloy C-276 / B574
4*	Ball	Alloy 400	Alloy C-276
5*	Spring	Alloy X-750 / AMS 5699	Alloy X-750 / AMS 5699
6*	O-ring	Fluorocarbon FKM	Perfluoroelastomer FFKM
7*	Stem	Alloy 400 or R-405 / B164	Alloy C-276 / B574
	Wetted Lubricant	PTFE - Based	

\*Wetted components

# How to Order

## Ordering Instructions

- 1 Locate the basic part number for the valve with the required end connection type and size from the table below. *Example: 4012*
- 2 Add designator for the required cracking pressure. *Example: 4012-10*
- 3 Add the body material designator to the part number. *Example: 4012-10-HC*
- 4 Add additional options and accessories in alphabetical order. *Example: 4012-10-HC-XP98*

Basic Part Number      Options

**A**   **B**   **C**      **D**

4012   -10   -HC      -XP98

**A** SERIES / SIZE  
40XX See Chart

**B** CRACKING PRESSURE

1/3    1/3 PSI  
1      1 PSI  
10    10 PSI

**D** OPTIONS

**SPECIAL CLEANING**  
-XP98    ASTM G93, Level C  
          and CGA G-4.1

**C** BODY MATERIAL  
-M    Alloy 400/R-405  
-HC   Alloy C-276

## 4000 Series

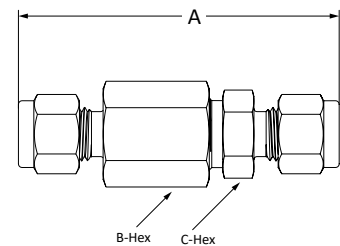

End Connection			Alloy 400 Part Number	Alloy C-276 Part Number	Cv	Dimensions in. (mm)		
Type	Inlet	Outlet				A	B	C
Fractional Tube Fitting	1/8	1/8	4002-M	4002-HC	0.66	2.60 (66.0)	3/4	5/8
	1/4	1/4	4012-M	4012-HC	0.66	2.67 (67.8)	3/4	5/8
Fractional Tube Fitting to Male NPT	1/8	1/8	4005-M	4005-HC	0.66	2.44 (62.0)	3/4	5/8
	1/4	1/8	4011-M	4011-HC	0.66	2.50 (63.5)	3/4	5/8
	1/4	1/4	4015-M	4015-HC	0.66	2.50 (63.5)	3/4	5/8

# Ball Valves

## EB Series One-Piece Encapsulated Ball Valves

SSP EB Series ball valves offer important improvements for the most popular valve design used in analytical instrumentation and other medium pressure applications. These include:

- The industry's first blowout proof stem standard design prevents accidental disassembly for improved safety
- One-piece packing encapsulates the trunnion-style ball eliminating dead space to maximize purgeability for clean and accurate samples. One-piece packing is standard on all EB Series valves.
- End-to-end dimensions match Swagelok® 40 Series valve dimensions

### General Specifications

Feature	Specification
Body Materials	Alloy 400, Alloy C-276
Packing Materials	Modified PTFE
Working Pressure	Up to 3000 psig (206 bar)
Temperature Range	-65 to 300°F (-53 to 148°C)
Flow Coefficient	0.8 to 12.0
End Connection Sizes	1/16 to 3/4 in.
Flow Patterns	2-way and 3-way Switching/Shut Off Valves. purging, sampling and other functions are available.

*Encapsulating PTFE packing eliminates dead space to improve sample quality*



*Blowout retainer clip prevents accidental disassembly*

### Applications

With an extended temperature range, low dead space, and the ability to seal at both high and low pressures, EB Series valves are suitable for a wide variety of instrumentation systems. They are widely used in the analytical instrumentation sampling and conditioning systems where clean and accurate sampling can have significant impact on product quality, process efficiency and productivity. In addition, EB Series ball valves can be used in process and equipment applications, such as painting, coating, filling and additive systems, where rapid and thorough cleaning and purging are required.

\*Swagelok® is a registered trademark of the Swagelok company

# Product Design

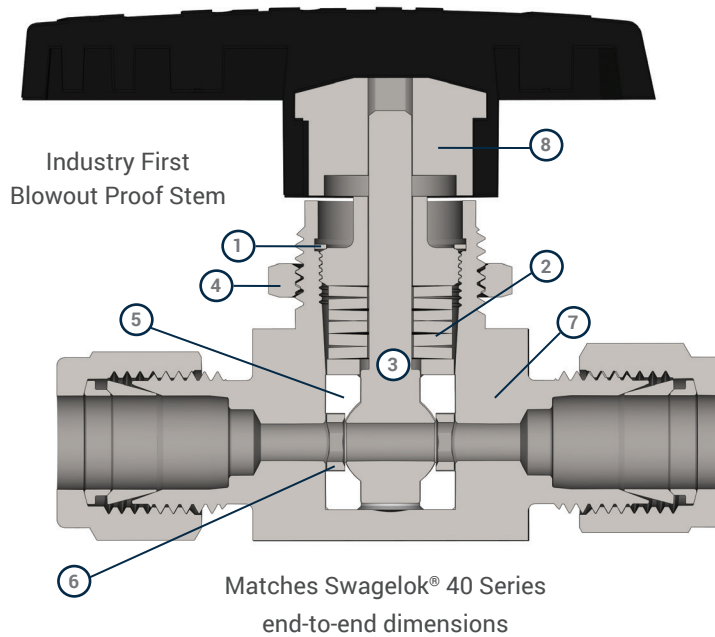

## 1 INDUSTRY FIRST BLOWOUT PROOF STEM

- Prevents accidental disassembly for improved safety and meets the most stringent safety standards including MSS SP-110

## 2 LIVE LOADED PACKING

- Reduces need for packing adjustments
- Packing is adjustable in-line. No special tools or adapters required
- Compensates for seat wear
- Improves performance in dynamic temperature applications

## 3 ONE-PIECE TRUNNION-STYLE BALL AND STEM

- Ensures alignment of ball in orifice
- Reduces seat wear
- Straight flow path allows cleaning and purging

## 4 PANEL MOUNTABLE

## 5 ENCAPSULATED ONE-PIECE PACKING IN ALL SIZES

- Eliminates dead space
- Reduces number of leak points
- Leak-tight from vacuum to maximum pressure

## 6 SUPPORT RINGS AND DISCS

- Protect packing
- Reduce packing extrusion

## 7 ONE-PIECE BODY WITH INTEGRAL END CONNECTIONS

- Matches Swagelok® 40 Series end-to-end dimensions
- Reduces the number of potential leak paths
- No end connections to loosen or O-rings to maintain

## 8 DURABLE DIRECTIONAL HANDLE

- Nylon handle with 316 stainless steel insert enhances strength and compatibility
- Handle and stem flats indicate flow direction
- Colored handles available

*Meets ASME B31.1 and B31.3 design pressure calculations*

# Materials of Construction

ID	Component	Material	
		Alloy 400	Alloy C-276
		Material Grade / ASTM Specification	
1	Handle	Nylon with SS insert	
2	Set Screw	17-4 PH	
3	Retaining Clip	302 SS	
4	Packing Bolt	Powdered Metal Alloy 400	Powdered Metal Alloy C-276
5	Springs	S17700 / A693	Alloy 718 / AMS 5596
6	Gland	Alloy 400 / B164	Alloy C-276 / B574
7*	Ball Stem	Alloy 400 / B164	Alloy C-276 / B574
8*	Packing	Modified PTFE / D1710	
9*	Side Rings	Powdered Metal Alloy 400	Powdered Metal Alloy C-276
10*	Side Discs	Powdered Metal Alloy 400	Powdered Metal Alloy C-276
11	Panel Nut	Powdered Metal 300 Series SS / B783	
12*	Body	Alloy 400 / B564	Alloy C-276 / B564
	Wetted Lubricant	Silicone-Based	
	Non-Wetted Lubricant	Molybdenum Disulfide	

\* Wetted components

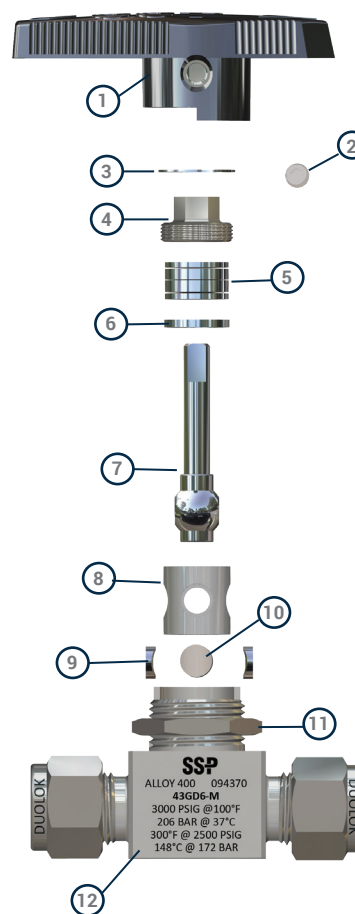

# Pressure-Temperature Tables

The table provides temperature ratings for both process and environmental temperatures.

Size	41		42		43		45	
Configuration	2-way/3-way		2-way/3-way		2-way	3-way	2-way	3-way
Temperature	Working Pressure - psig (bar)							
-65 to 150° F (-53 to 65° C)	2500 (172)	2500 (172)	2500 (172)	2500 (172)	3000 (206)	2500 (172)	2500 (172)	1500 (103)
200°F (93°C)	2500 (172)	2500 (172)	2500 (172)	2500 (172)	2800 (193)	2500 (172)	-	-
250°F (121°C)	2500 (172)	2500 (172)	2500 (172)	2500 (172)	2650 (183)	2500 (172)	-	-
300°F (148°C)	2500 (172)	2500 (172)	2500 (172)	2500 (172)	2500 (172)	2500 (172)	-	-

# How to Order

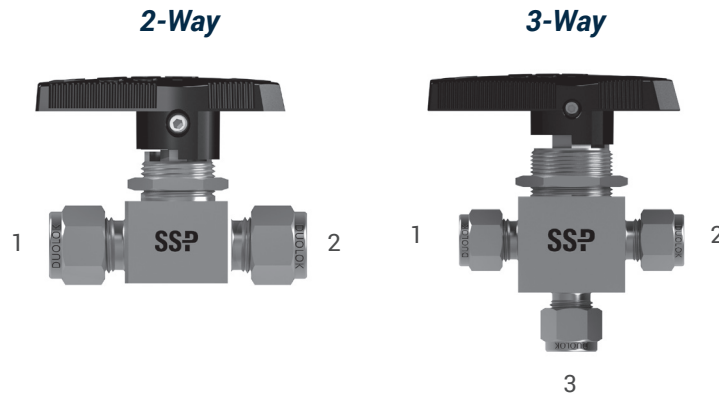

## Ordering Instructions

**Ordering EB Series valves requires the following steps:**

- ① Locate the Basic Part Number table from page 48
- ② Locate the Basic Ordering Number for the valve end connection type(s), size(s) and the orifice size.  
*Example: 43GD4*  
**Note:** End connections are designated in the part numbers according to the diagrams above.
- ③ Locate and add the Body Material Designator from page 49 to the part number – on page 48.  
*Example: 43GD4-M*
- ④ Add designators for other options from page 48.

# Special Orders

The Basic Ordering Numbers and Dimensions tables contain only the most popular valve configurations; many more are available. If the required valve configuration is not in the Basic Ordering Numbers and Dimensions tables, use the chart below to build part numbers for quotation purposes.

<b>A</b>	<b>B</b>	<b>C</b>	<b>D</b>	<b>E</b>	<b>F</b>	<b>G</b>
<b>43</b>	<b>G</b>	<b>X</b>	<b>D4</b>	<b>4PF</b>	<b>-M</b>	<b>-GR</b>
Valve Series/Size	Packing Material	Flow Path	Inlet/Outlet		Body Material	Options

<b>A</b> <b>Body/Orifice Size</b>	<b>F</b> <b>Body Material</b>
41 0.093 in.	-M Alloy 400
42 0.125 in.	-HC Alloy C-276
43 0.187 in.	
45 0.406 in.	

<b>B</b> <b>Packing</b>
G PTFE

<b>C</b> <b>Body/Flow Path</b>
Blank 2 way
L 2-way Sample Transfer
DP 2-way Downstream Drain/Purge
UP 2-way Upstream Drain/Purge
X 3-way
XQS Quarter Turn Switching
XTF 3-way Tee Flow
XTS 3-way Tee Flow Switching

<b>D</b> + <b>E</b> <b>Inlet<sup>2</sup> + Outlet Type and Size<sup>2</sup></b>	
D Duolok® Tube Fitting	Fractional Sizes:
PF Female NPT	2 1/8 in.
	4 1/4 in.
	6 3/8 in.
	8 1/2 in.

## **G** Options<sup>1</sup>

<b>HANDLES</b>
(Blank) Black
-GR Green
-RD Red
-BL Blue
-YW Yellow
-OG Orange
-NH No Handle

## **Locking Devices**

-LD Standard
-LD2 Compact

## **Special Cleaning**

-XP97 No Lube
-XP98 Oxygen compatible lubricant, per ASTM G93, Level C and CGA G-4.1

EB series ball valves should only be used in the full on or full off position. Throttling may damage the valve.

Packing adjustments are required for applications with working pressure higher than 1000 psig (69 bar) or if the valves have been exposed to high or low temperatures prior to installation. Instructions for packing adjustments are included with each valve.

Valves that have not been actuated for extended periods of time may require greater actuation torque.

<sup>1</sup> Add options designators to the end of the Base Part Number in alphabetical order.

<sup>2</sup> Tube end connection part numbers are formatted "Type" followed by "Size." Example: D6.

Pipe end connections are formatted "Size" followed by "Type." Example: 6PF

# EB Series - Ball Valves

## Straight Pattern

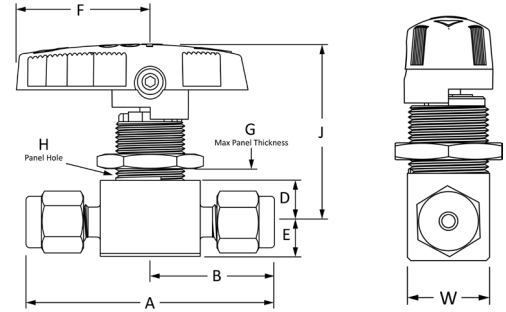
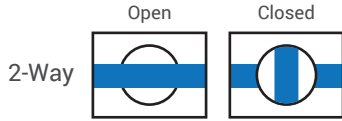

End Connection			Monel Part Number	Hastelloy C Part Number	Orifice in. (mm)	CV	Dimensions, in. (mm)								
Type	Inlet Size	Outlet Size					A	B	D	E	F	G	H	J	W
Fractional Tube Fitting	1/8	1/8	41GD2-M	41GD2-HC	0.093 (2.36)	0.20	2.01 (51.1)	1.01 (25.7)	0.34 (8.6)	0.28 (7.1)	1.09 (27.7)	1/4 (6.4)	19/32 (15.1)	1.45 (36.8)	0.58 (14.7)
	1/4	1/4	43GD4-M	43GD4-HC	0.187 (4.75)	1.4	2.39 (60.7)	1.20 (30.5)	0.44 (11.2)	0.38 (9.7)	1.43 (36.3)	3/16 (4.8)	25/32 (19.8)	1.53 (38.9)	0.78 (19.8)
	3/8	3/8	43GD6-M	43GD6-HC	0.187 (4.75)	1.5	2.58 (65.5)	1.29 (32.8)	0.44 (11.2)	0.38 (9.7)	1.43 (36.3)	3/16 (4.8)	25/32 (19.8)	1.53 (38.9)	0.78 (19.8)
	1/2	1/2	45GD8-M	45GD8-HC	0.406 (10.3)	12.0	3.92 (99.6)	1.96 (49.8)	0.69 (17.5)	0.69 (17.5)	3.02 (76.7)	3/8 (9.5)	1 1/2 (38.1)	2.57 (65.3)	1.50 (38.1)
Female NPT	1/4	1/4	43G4PF-M	43G4PF-HC	0.187 (4.75)	0.90	2.06 (52.3)	1.03 (26.2)	0.44 (11.2)	0.38 (9.7)	1.43 (36.3)	3/16 (4.8)	25/32 (19.8)	1.53 (38.1)	0.78 (19.8)
	3/8	3/8	45G6PF-M	45G6PF-HC	0.406 (10.3)	9.8	3.12 (79.2)	1.56 (39.6)	0.69 (17.5)	0.69 (17.5)	3.02 (76.7)	3/8 (9.5)	1 1/2 (38.1)	2.57 (65.3)	1.50 (38.1)
	1/2	1/2	45G8PF-M	45G8PF-HC	0.406 (10.3)	6.3	3.12 (79.2)	1.56 (39.6)	0.69 (17.5)	0.69 (17.5)	3.02 (76.7)	3/8 (9.5)	1 1/2 (38.1)	2.57 (65.3)	1.50 (38.1)

## 3-Way

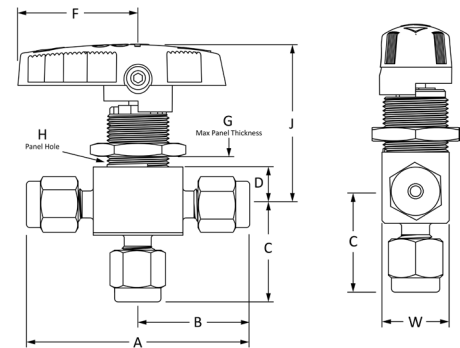
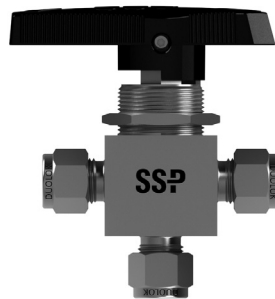
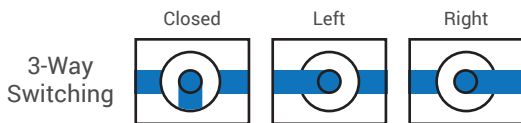

End Connection			Monel Part Number	Hastelloy C Part Number	Orifice in. (mm)	CV	Dimensions, in. (mm)								
Type (Sides/Bottom)	Bottom	Sides					A	B	C	D	F	G	H	J	W
Fractional Tube Fitting	1/8	1/8	41GXD2-M	41GXD2-HC	0.093 (2.36)	0.15	2.01 (51.1)	1.01 (25.7)	0.97 (24.6)	0.34 (8.6)	1.09 (27.7)	1/4 (6.4)	19/32 (15.1)	1.45 (36.8)	0.58 (14.7)
	1/4	1/4	42GXD4-M	42GXD4-HC	0.125 (3.18)	0.35	2.21 (56.1)	1.10 (27.9)	1.07 (27.2)	0.34 (8.6)	1.09 (27.7)	1/4 (6.4)	19/32 (15.1)	1.45 (36.8)	0.58 (14.7)
	1/4	1/4	43GXD4-M	43GXD4-HC	0.187 (4.75)	0.90	2.39 (60.7)	1.20 (30.6)	1.17 (29.7)	0.44 (11.2)	1.43 (36.3)	3/16 (4.8)	25/32 (19.8)	1.53 (38.9)	0.78 (19.8)
	3/8	3/8	43GXD6-M	43GXD6-HC	0.187 (4.75)	0.90	2.58 (65.5)	1.29 (32.8)	1.29 (32.8)	0.44 (11.2)	1.43 (36.3)	3/16 (4.8)	25/32 (19.8)	1.53 (38.9)	0.78 (19.8)
	1/2	1/2	45GXD8-M	45GXD8-HC	0.406 (10.3)	4.6	3.48 (88.4)	1.74 (44.2)	1.74 (44.2)	0.69 (17.5)	3.02 (76.7)	3/8 (9.7)	1 1/2 (38.1)	2.57 (65.3)	1.50 (38.1)



# FB Series

## Multipurpose Ball Valves

FB Series ball valves use a unique combination of features to provide leak-tight performance at high and low pressures and temperatures, high cycle-life, low maintenance, lower actuating torque, and design flexibility.

*Features include:*

- Working Pressures: Up to 6000 psig (413 bar)
- Temperature range: -15 to 400°F (-26 to 204°C)
- Flow: Cv up to 7.2
- Live-loaded seats
- Robust body and stem seals
- Wide variety of end connection size and type combinations

### Applications

FB Series ball valves are very versatile. They can be used in both high and low pressure instrumentation systems, process lines, utility systems, and other applications. Designed for higher pressures than many floating ball valves, they can be used in applications such as high-pressure instrumentation and control systems. Unlike many floating ball designs, FB Series valves are also suitable for low and dynamic pressure conditions. In addition, end-screw construction allows users to specify a wide variety of end connection size and type combinations.

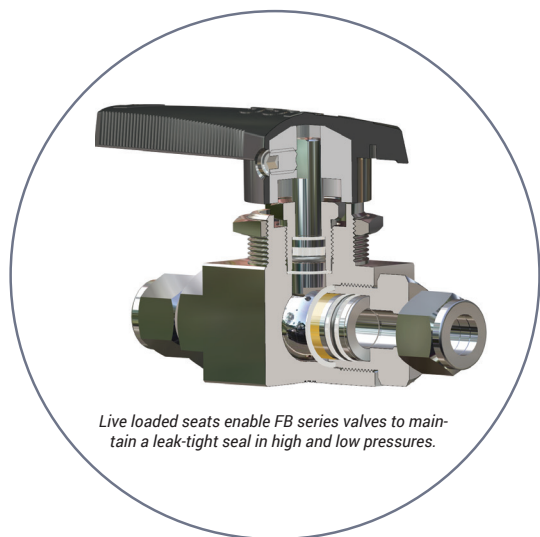

*Live loaded seats enable FB series valves to maintain a leak-tight seal in high and low pressures.*

## How it works

The images below explain how live-loaded seats work to keep a leak-tight seal in high and low pressures, reduce actuation torque and improve cycle life.

Open

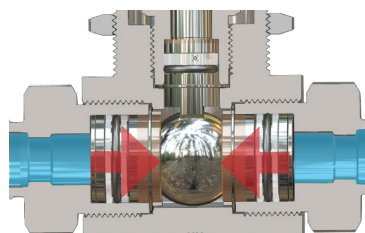

When the valve is open fluid flows through the valve (blue). Force from the springs (red arrows) applies pressure evenly to the seat gland, seat and ball.

Closed - High Pressure

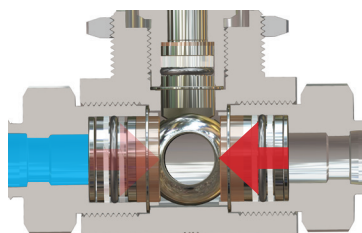

When the ball is closed under high pressure, the force of the upstream pressure forces the ball against the downstream seat to form a tight seal. Resistance from the downstream spring cushions the force of the ball against the seat to protect the seat and makes the valve easier to actuate.

Closed - Low Pressure

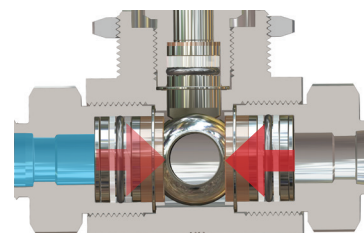

Under low pressure, there is much less upstream pressure on the ball and downstream seat. Without the mechanical force exerted by the seats and springs, the ball could disengage from the downstream seat.

# Product Design

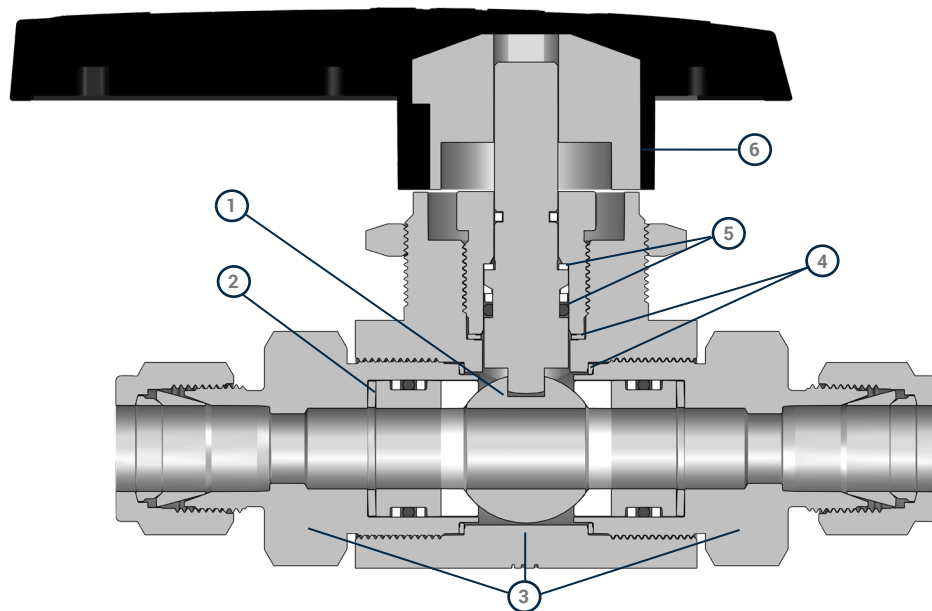

Drop in replacement size for Swagelok® AFS and SK Series Valves.  
Meets ASME B31.3 design pressure calculations.

- |  |  |
|--|--|
| <p><b>1 FLOATING BALL DESIGN</b></p> <ul style="list-style-type: none"> <li>• Upstream pressure assists sealing against the downstream seat</li> </ul>   | <p><b>4 ROBUST BODY SEALS</b></p> <ul style="list-style-type: none"> <li>• Leak-tight envelope</li> </ul>  |
| <p><b>2 LIVE-LOADED SEATS</b></p> <ul style="list-style-type: none"> <li>• Improves sealing in high, low and dynamic pressure and flow conditions</li> <li>• Fully supported seats improve cycle-life</li> <li>• PEEK or PTFE seats for chemical compatibility and durability</li> </ul> | <p><b>5 STEM BEARING AND O-RING STEM SEAL</b></p> <ul style="list-style-type: none"> <li>• Leak-tight seal</li> <li>• Lower actuation torque</li> <li>• No need for packing adjustments</li> </ul>   |
| <p><b>3 THREE-PIECE DESIGN</b></p> <ul style="list-style-type: none"> <li>• Easier maintenance</li> </ul>  | <p><b>6 DURABLE DIRECTIONAL HANDLE</b></p> <ul style="list-style-type: none"> <li>• Stainless steel reinforced nylon handle for durability</li> <li>• Indicates flow direction</li> <li>• Large ergonomic handle for easier actuation</li> </ul> |

# Temperature Pressure Tables

Material	Alloy 400				Alloy C-276		
	PTFE	PEEK			PTFE	PEEK	
End Connections	D4, D6, D8	D4	D6	D8	D4, D6, D8	D4, D6	D8
Temperature, °F (°C)	Working Pressure, psig (bar)						
-15 (-26) to 0 (-18)	1500 (103)	6000 (413)	6000 (413)	4450 (306)	-	-	-
100 (37)	1250 (86.1)		5750 (396)	4150 (286)	1500 (103)	6000 (413)	4750 (327)
150 (65)	1000 (68.9)	5400 (372)	3900 (268)	1250 (86.1)			
200 (93)	600 (41.3)	5200 (358)	3750 (258)	1000 (68.9)			
250 (121)	300 (20.6)	3000 (206)	3000 (206)	3000 (206)	300 (20.6)	3000 (206)	3000 (206)
300 (148)	100 (6.89)	2000 (137)	2000 (137)	2000 (137)	100 (6.89)	2000 (137)	2000 (137)
350 (176)	-	1000 (68.9)	1000 (68.9)	1000 (68.9)	-	1000 (68.9)	1000 (68.9)

**NOTE:** Ratings based on fluorocarbon FKM O-rings in Alloy 400 valves and Perfluoroelastomer FFKM O-rings in Alloy C-276 valves.

## Materials of Construction

ID	Component	Material / Specification	
		Alloy 400	Alloy C-276
1	Handle	Nylon with SS Insert	Nylon with SS Insert
2	Handle Set Screw	17-4 PH	17-4 PH
3*	Packing Bolt	Alloy 400 or R-405 / B164	Alloy C-276 / B574
4	Stem Bearing	PEEK	PEEK
5	Stem Guide Ring	PTFE / D1710	PTFE / D1710
6	Chamfered Back-up Ring	PEEK	PEEK
7	Stem Back-up Ring	PTFE / D1710	PTFE / D1710
8*	Stem O-ring	Fluorocarbon FKM	Perfluoroelastomer FFKM
9*	Packing Bolt Gasket	Alloy 400 or R-405 / B164	Alloy C-276 / B574
10*	Stem	Alloy 400 or R-405 / B164	Alloy C-276 / B574
11*	Ball	Alloy 400 or R-405 / B164	Alloy C-276 / B574
12	Panel Nut	Powder Metal 316SS	Powder Metal 316SS
13*	Body	Alloy 400 / B564	Alloy C-276 / B564
14*	End Screw Gasket	Alloy 400 or R-405 / B164	Alloy C-276 / B574
15*	Seat	PEEK or PTFE /D1710	PEEK or PTFE /D1710
16*	Seat Gland	Alloy 400 or R-405 / B164	Alloy C-276 / B574
17*	Seat Back-up Ring	PTFE / D1710	PTFE / D1710
18*	Seat O-ring	Fluorocarbon FKM	Perfluoroelastomer FFKM
19*	Seat Spring	Alloy 718 / AMS 5596	Alloy 718 / AMS 5596
20*	End Screw	Alloy 400 or R-405 / B164	Alloy C-276 / B574
	Wetted Lubricant	PTFE-Based	PTFE Based

\*Wetted components

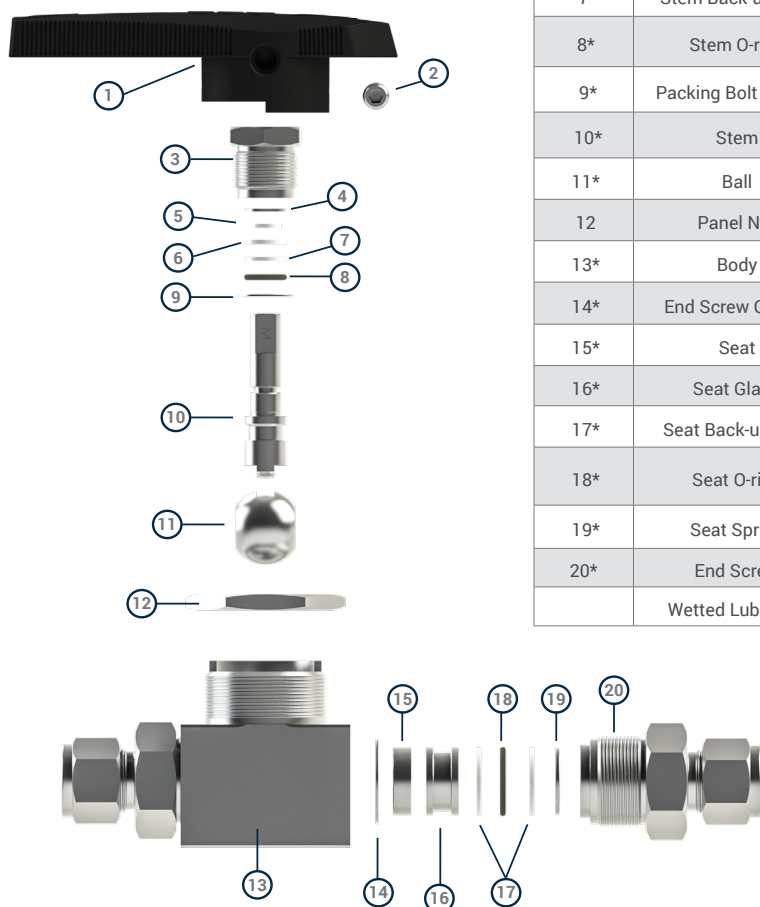

# How to Order

## Ordering Instructions

Ordering FB Series valves requires the following steps:

- 1 Locate the basic part number with the required end connection type, size, and body material from the table below. Example: **38PD8-M**
- 2 Add designators for other options. Example: **38PD8-RD-XP98**

(basic ordering number)

(options)

**A** **B** **C**

38P D6 -M

**D**

-GR -LD

### A VALVE SIZE

36P 0.250 Ball Orifice (PEEK SEAT)  
 38P 0.472 Ball Orifice (PEEK SEAT)  
 36T 0.250 Ball Orifice (PTFE SEAT)  
 38T 0.472 Ball Orifice (PTFE SEAT)

### C BODY MATERIAL

-M Alloy 400  
 -HC Alloy C-276

### B INLET TYPE + SIZE

D Duolok® Tube Fitting

Fractional Sizes:

4 1/4 in.  
 6 3/8 in.  
 8 1/2 in.  
 12 3/4 in.

### D OPTIONS

#### HANDLES

(Blank) Black  
 -GR Green  
 -RD Red  
 -BL Blue  
 -YW Yellow  
 -OG Orange  
 -NH No Handle

#### SPECIAL CLEANING

-XP98 ASTM G93, Level C  
 and CGA G-4.1

#### OTHER OPTIONS

-LD Locking Device

## FB Series

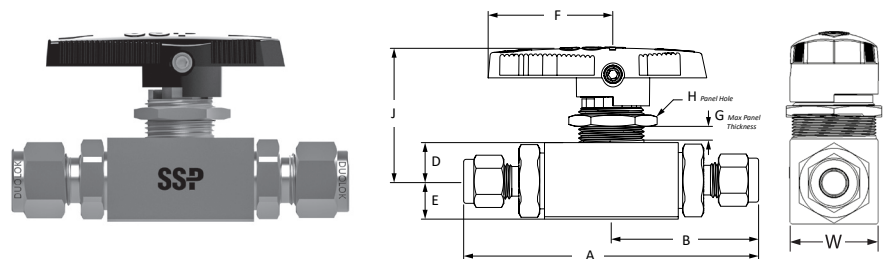

Connection		Alloy 400 Part Number	Alloy C-276 Part Number	Orifice in. (mm)	Cv	Dimensions, in. (mm)								
Type(s)	Size					A	B	D	E	F	G	H	J	W
Fractional Tube Fitting	1/4 in.	36PD4-M	36PD4-HC	0.188 (4.78)	1.3	3.60 (91.4)	1.80 (45.7)	0.44 (11.2)	0.44 (11.2)	1.43 (36.3)	3/16	25/32	1.53 (38.9)	1.00 (25.4)
	3/8 in.	36PD6-M	36PD6-HC	0.250 (6.35)	2.5	3.73 (91.5)	1.86 (47.2)	0.44 (11.2)	0.44 (11.2)	1.43 (36.3)	3/16	25/32	1.53 (38.9)	1.00 (25.4)
	1/2 in.	38PD8-M	38PD8-HC	0.406 (10.31)	7.2	4.80 (122)	2.40 (61.0)	0.75 (19.1)	0.70 (17.8)	3.02 (76.7)	3/8	1 1/2	2.59 (65.8)	1.50 (38.1)
	3/4 in.	38PD12-M	-	0.472 (11.99)	7.1	4.80 (122)	2.40 (61.0)	0.75 (19.1)	0.70 (17.8)	3.02 (76.7)	3/8	1 1/2	2.59 (65.8)	1.50 (38.1)

# Quick Connects

## QC Series

SSP Quick Connects are designed to provide a convenient way to connect and disconnect fluid lines, creating a leak tight seal without the use of tools, MAWP up to 3000 psig (206 bar) and temperature ranges from 10° to 400°F (-12° to 204°C) the QC Series Quick Connects are available in DESO (double ended shut off) connection type.

## Product Design

- 1 **AUTOMATIC COUPLING**
  - Push to connect design means no tools are required
- 2 **LOCKING BALL DESIGN**
  - Easily connects & disconnects
- 3 **O-RING SEAL**
  - O-ring positioned to minimize spillage
- 4 **VALVE STOPS**
  - Prevent flow checking during flow surges

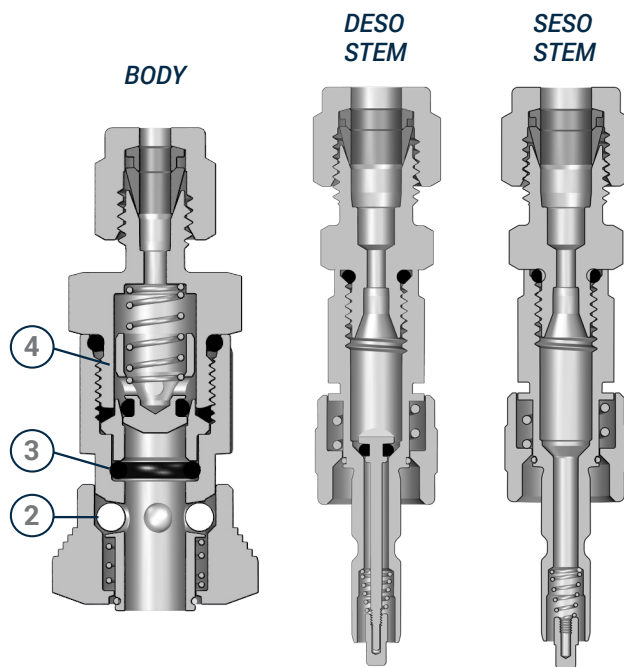

## QC Series Materials of Construction

ID	Component	Monel
1	Sleeve Snap Ring	316 SS
2	Sleeve	316 SS / A479
3	Sleeve Spring	316 SS
4	Locking Balls	316 SS
5	Body *	Alloy 400 / B164
6	Stem Seal *	Fluorocarbon FKM
7	Insert *	Alloy 400 / B164
8	Insert Seal *	Fluorocarbon FKM
9	Valve Seal *	Fluorocarbon FKM
10	Valve *	Alloy 400 / B164
11	Valve Spring *	Alloy X-750 / AMS 5699
12	Adapter Seal *	Fluorocarbon FKM
13	Adapter *	Alloy 400 / B164
14	Sleeve Snap Ring	316 SS
15	Sleeve	316 SS /A479
16	Sleeve Spring	316 SS
17	Valve Cap *	Alloy 400 / B164
18	Valve Spring *	Alloy X-750 / AMS 5699
19	Stem Body *	Alloy 400 / B164
20	Valve Seal *+	Fluorocarbon FKM
21	Valve **	Alloy 400 / B164
22	Adapter Seal *	Fluorocarbon FKM
23	Adapter *	Alloy 400 / B164

\*Wetted Components

+DESO only

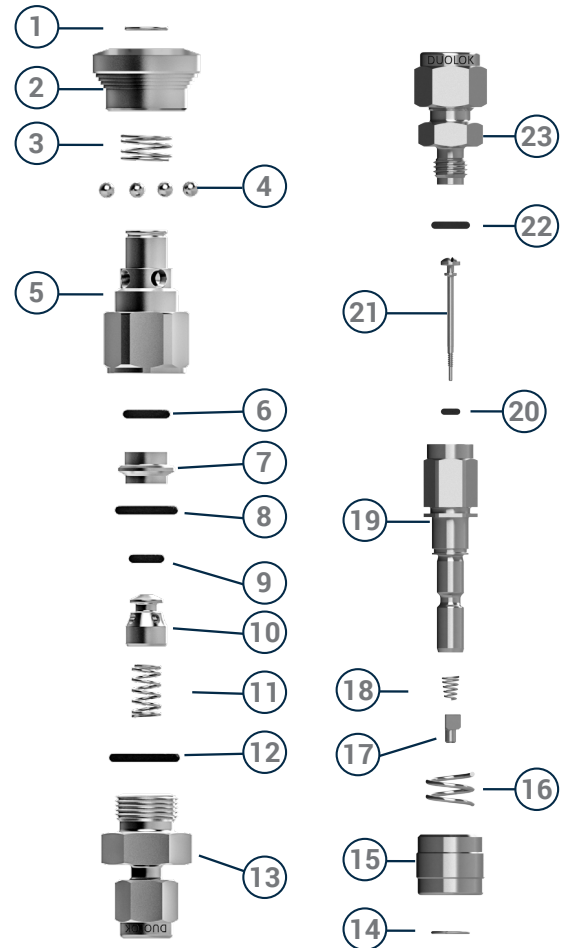

## QC Series Temperature - Pressure

SERIES	QC4
MATERIAL	Monel
TEMPERATURE °F (°C)	WORKING PRESSURE, PSIG (BAR) <sup>1</sup>
10 to 100 (-12 to 37)	3000 (206)
150 (65)	2750 (189)
200 (93)	2300 (158)
250 (121)	1850 (127)
300 (148)	1400 (96.4)
350 (176)	950 (65.4)
400 (204)	500 (34.4)

<sup>1</sup>Based on FKM O-rings.

# How to Order

## Ordering Instructions

- 1 Select the basic ordering number from the Part Numbers and Dimensions table based on the end connections and orifice size for the valve. *Example: QC4-D-D4-M*
- 2 Select the body or stem designator, then add it to the base part number. *Example: QC4-D-D4-M*
- 3 Select the inlet type and size designator, then add it the part number. *Example: QC4-D-D4-M*
- 4 Select the material designator, then add it the part number. *Example: QC4-D-D4-M*
- 5 Select the O-ring designator. *Example: QC4-D-D4-M-KZ*

### Stems

	<b>A</b>	<b>B</b>	<b>C</b>	<b>D</b>	<b>E</b>
DESO	QC4	-D	-D4	-M	

### Bodies

	<b>A</b>	<b>B</b>	<b>C</b>	<b>D</b>	<b>E</b>
	QC4	-B	-D4	-M	

**A** STEM/BODY SIZE  
QC4 1/4 Orifice size

**B** CONNECTION TYPE  
B Bodies  
D DESO (Double end shutoff)  
S SESO (Single end shutoff)

**C** INLET TYPE & SIZE  
D4 Duolok Tube Fitting 1/4 in.  
4PM Male NPT 1/4 in.  
4PF Female NPT 1/4 in.

**D** MATERIAL  
-M Alloy 400

**E** O-RINGS  
(Blank) fluorocarbon FKM  
-KZ Kalrez® FFKM

Kalrez® is a registered trademark of DuPont Performance Elastomers.

# Quick Connects - QC Series

## DESO Stems

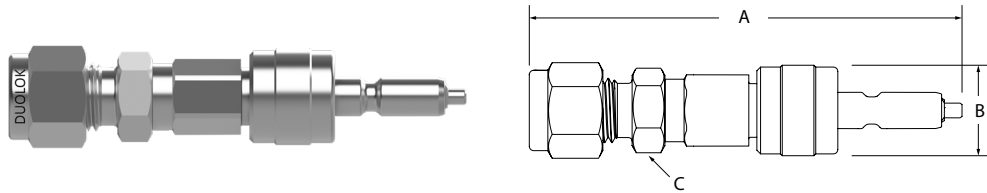

End Connection	Series	Double End Shut-Off	Single End Shut-Off	Dimensions in. (mm)		
				A	B	C
Fractional Tube Fitting	QC4	QC4-D-D4-M	QC4-S-D4-M	2.90 (73.7)	0.62 (15.8)	1/12 (12.7)
Female NPT	QC4	QC4-D-4PF-M	QC4-S-4PF-M	2.74 (69.6)	0.62 (15.8)	3/4 (19.1)
Male NPT	QC4	QC4-D-4PM-M	QC4-S-4PM-M	2.78 (70.6)	0.62 (15.8)	9/16 (14.3)

## Bodies

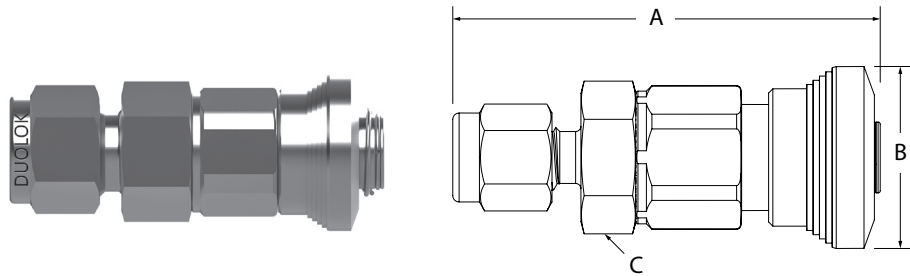

End Connection	Series	Monel Ordering Number	Dimensions in. (mm)		
			A	B	C
Fractional Tube Fitting	QC4	QC4-B-D4-M	2.11 (53.6)	0.86 (21.8)	5/8 (15.9)
Female NPT	QC4	QC4-B-4PF-M	2.11 (53.6)	0.86 (21.8)	3/4 (19.1)



# More SSP Products



## Tube Fittings

*Duolok and Griplok two-ferrule and Unilok® single ferrule tube fittings provide leak-tight installation even when intermixed with Swagelok®, Hoke Gyrolok® and Parker CPI™ fittings.*



## Valves

*The SSP valve offering includes ball, check, metering, needle, toggle, plug, bleed, and purge valves for pressures up to 10,000 psig.*



## Tubing

*SSP offers straight and coiled seamless 316 stainless steel instrumentation tubing for instrumentation, process and utility applications.*



## Pipe Fittings

*TruFit and TruFit 10K pipe fittings are available in a wide range of weld, threaded and flared connections.*

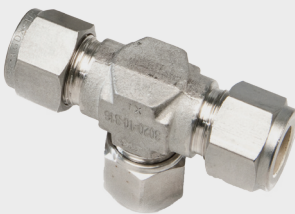

## Filters

*SSP in-line and tee-type filters trap particles to clean sample fluids and protect sensitive process and analytical instrumentation components and equipment.*



## Hose

*TruFit PTFE-lined and flexible metal core hose assemblies are used in a variety of instrumentation, utility, biopharm and other applications.*



## Tools & Accessories

*SSP TurnPro professional hand tools, power tools and installation training make quality tube system installation faster and easier.*



## Quick Connects

*SSP offers single-end shutoff, double-end shut off, and full-flow quick connects for instrumentation and process applications.*

# Safety & Warranty

## SAFETY

To help ensure the safe and reliable performance of tube fitting products, complete system design must be considered prior to the installation of the tubing and tube fittings. Determining the design compatibility of materials, media, flows, temperatures and pressures; as well as implementing proper installation, operation and maintenance of the system are the responsibilities of the systems' owners, designers and users.

## SSP SAFETY REMINDERS

All SSP products are designed and manufactured with safety in mind. The following is a limited list of general safety tips as reminders of good safety practices:

- Do not install, tighten or loosen a tube fitting while the system is under pressure.
- Do not loosen a tube fitting, nut or plug to relieve or bleed system pressure.
- Always use a back-up wrench to hold the tube fitting body steady when tightening or loosening tube fitting nuts.
- There is no need to disassemble a new tube fitting prior to use.
- Use proper thread lubricants and sealants on tapered pipe threads.
- Very soft, pliable plastic tubing requires a tube insert.
- Tube fitting and tubing material should be similar (stainless steel fittings on stainless steel tubing, brass fittings on copper tubing, etc.) with the tubing material being fully annealed. For more specific information, refer to the Selection Guide for Instrumentation Fittings and Tubing on pages 252-256.
- Do not weld tube fittings that are assembled. Prior to welding, remove the nut and ferrules and protect the seat and thread area of the tube fitting by covering with a plug or another nut.



## Important Information

*IMPROPER SELECTION OR IMPROPER USE OF THE PRODUCTS DESCRIBED HEREIN OR RELATED ITEMS CAN CAUSE PERSONAL INJURY AND PROPERTY DAMAGE. It is the sole responsibility of the system designers and users to properly select and use products for their specific applications. This document has been provided to users with technical expertise as a reference for further investigation to determine specific product needs relative to their design requirements.*

## Testing

*All SSP valves are factory tested with Nitrogen to 1000 psig (69 bar) at 70°F (20°C).*

## Warranty

*SSP valves are backed by the SSP Limited Life Time Warranty. This warranty is available from your local distributor or at [www.mySSP.com](http://www.mySSP.com).*

## SSP LIFETIME LIMITED WARRANTY

SSP guarantees all Duolok tube fittings and Duolok tube fitting components to be free from defects in materials and workmanship. Additionally, SSP guarantees Duolok product performance to the published catalog specifications when properly installed according to the catalog selection and installation instructions. To initiate a warranty claim, suspected defective product must be returned to SSP with the nature of potential defect documented for factory evaluation. Any product with a determined defect in material or workmanship will be replaced with equivalent product at no charge.

This warranty comprises the sole and entire warranty pertaining to items provided hereunder. There is no other warranty, guarantee, express or implied representation of any kind whatsoever. All other warranties including, but not limited to, merchantability and fitness for purpose, whether express, implied, or arising by operation of law, course of dealing, or trade usage are hereby disclaimed. There are no warranties which extend beyond the description on the face hereof; and this warranty does not apply in cases of abuse, mishandling, or normal use depreciation. In no event, whether alleged to arise from breach of contract, express or implied warranty, by operation of law, negligence or otherwise, will SSP be liable for any incidental, consequential, lost property, or other special damages of any kind whatsoever. The exclusive, only remedy under this warranty is the replacement of determined defective parts as set forth above.



*(This page is intentionally left blank)*

# SSP

Founded 1926

Privately owned, third generation business

Modern single-site vertically integrated manufacturing facility

DFARS-compliant raw material

ISO 9001 quality management system

Limited Lifetime Warranty



8250 Boyle Parkway • Twinsburg, OH 44087  
330-425-4250 • [www.mySSP.com](http://www.mySSP.com)